

**PROVISIONAL**

**ISOTECH**

✓ The Source for Calibration Professionals



Portable Dry Blocks,  
Liquid Baths and  
Multi-functional Heat Sources

The **NEW** Advanced Range of  
Portable Temperature Calibrators

# Advanced Range

Isotech has been providing calibration solutions for more than 30 years, from Primary Standards for National Metrology Institutes through to handheld calibrators for service engineers.

Our portable calibrators have set a number of world firsts, the first Dry Blocks to feature an independent inbuilt temperate indicator and the first Dry Blocks to reach -100°C. The award winning ISOCAL-6 was the first calibrator, to offer both Dry Block and Liquid Bath use, and remains the only device to offer six modes of calibration.

These new advanced models add extra features bring benefits of greater performance, more input channels, advanced logging and remote monitoring with a bright full colour display.

Isocal-6	TEMP. RANGE	PAGE
Hyperion / Drago .....	-25°C to 250°C .....	4
Europa / Venus / Calisto .....	-45°C to 250°C .....	8

Dry Block Calibration		
Jupiter .....	35°C to 660°C .....	12
Gemini .....	35°C to 700°C .....	16
Pegasus .....	150°C to 1200°C .....	20

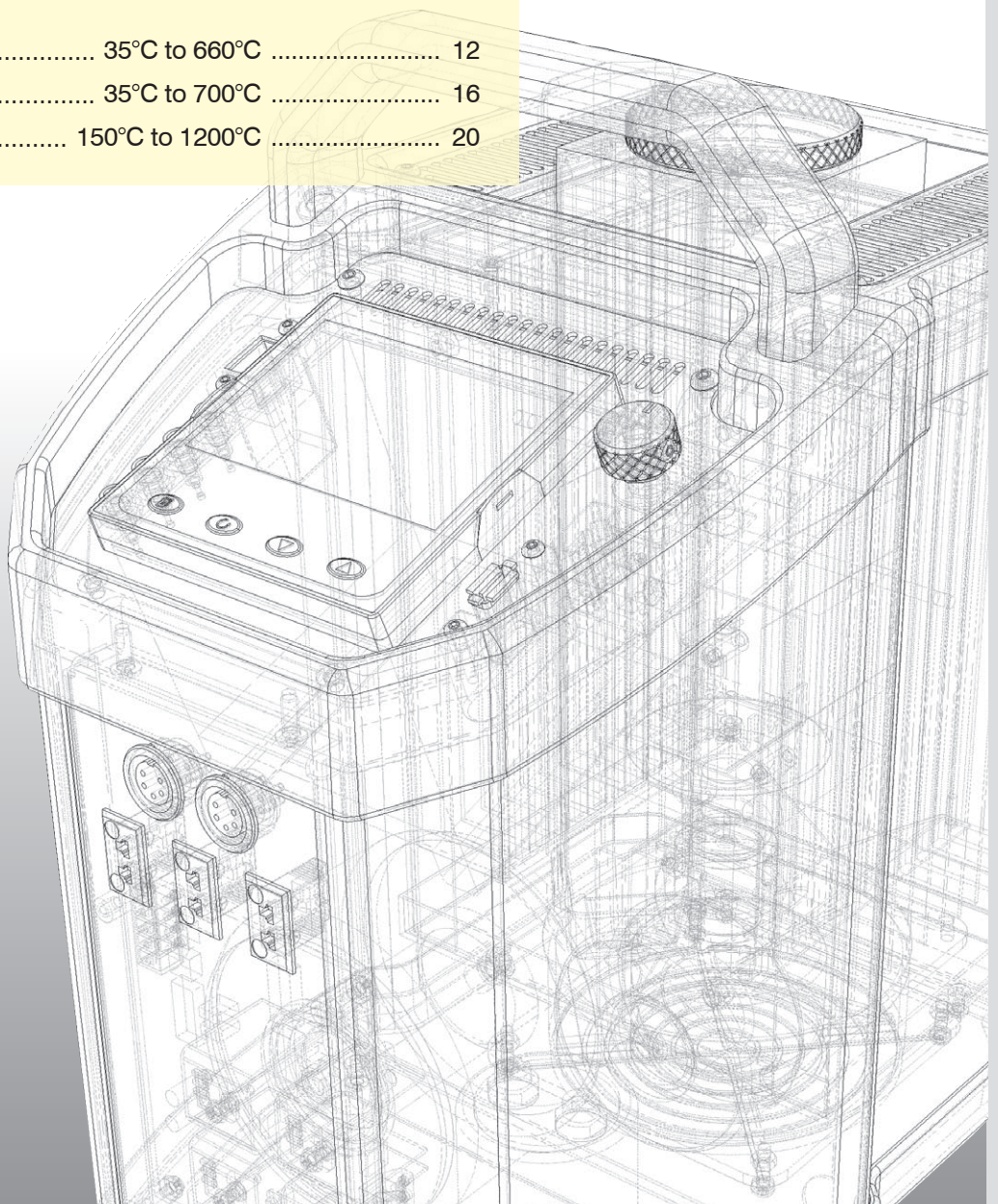

MODEL

# ADVANCED

## ■ Best Performance

- Benefit from advanced temperature controller that provides best performance
- Resolution to 0.001°C - Superior Stability
- Control parameters automatically optimised with temperature

## ■ Easily View in all conditions

- Large Bright Colour Display
- Similar to Smartphone
- Crystal clear display with full colour graphics

## ■ Thermostat Testing

- Test Two Thermostats Simultaneously

## ■ View from Anywhere

- 21st Century Connectivity with Ethernet and inbuilt webserver
- Connect to the network and view the calibrator from anywhere, on your Notepad, Tablet or Smartphone



## ■ Save Time and Money

### AUTOMATIC TEMPERATURE CYCLING

- Program the ADVANCED with the temperature points you need, store commonly used ranges. The calibrator can then automatically follow these points and log your data

## ■ Safely store and secure all the data you need

- Massive Internal Memory can safely store all your data
- Store a lifetime of data on a USB Drive
- Open CSV Files or Secure File Format for Data Security

## ■ Speaks five languages

- English, French, German, Italian and Spanish
- Simple to use with clear user interface

## ■ Connect More Probes

### UP TO 3 INPUT CHANNELS

- Inbuilt reference system two universal inputs for PRT, Thermocouple or Process Input and a third thermocouple input
- Input types include Process Input including 4-20mA, PRT, and Thermocouple Types B, C, D, E, J, K, L, N, R, S, T, U

## ■ Greater Accuracy

- Eliminate Offsets
- Connect a reference probe to one of the external probe inputs and the calibrator can trim the block temperature to remove offsets

## ■ The Software You need

- PC Tools for reviewing data and creating calibration temperature programs



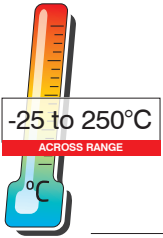

**NEW**  
**Advanced** **ISOCAL - 6 Range**  
**Hyperion • Drago**

- Advanced Features including inbuilt three channel temperature indicator
- Portable Liquid Bath with large 65mm volume
- Convertible for Dry Block and multi-function use

The Hyperion and Drago have large calibration volumes, 65mm x 160mm deep, which makes them ideal to use as portable liquid baths. Stirred liquid baths are suitable for temperature sensors of all types, sizes and shapes. Liquid Baths can provide smaller calibration uncertainties than dry blocks and, when used with suitable reference thermometers, accuracies of up to 0.005°C can be achieved.

These models are part of the award winning Isocal-6 family and with a reference probe can be used with different accessories for Dry Block, Infrared, Surface Calibration and even with ITS-90 Fixed Point Cells for uncertainties to 0.001°C. In Dry Block Mode the large 65mm diameter block allows for the calibration of either larger probes or for calibrating many sensors simultaneously.

As a Liquid bath the sensors can be placed directly into the stirred liquid thus avoiding the need for specially drilled blocks. If the liquid is directly in the block then the controller only model, or Basic (B) model, can be selected. However, instead of putting liquids directly in the block liquid containers can be used to facilitate rapid change of fluids. For greater accuracy, or when using a Liquid Container, Dry Block Insert, Blackbody Target or the Surface Sensor Kit a separate reference thermometer should be used to compensate for the varying offset between the controller and the accessory temperature.

I-Cal EASY calibration software can be added to create a powerful solution for the automatic calibration of thermometers.

These new ADVANCED models offer a wide range of features and benefits including an independent three



<http://www.isotech.co.uk/industrial/>

channel temperature indicator allowing test probes to be compared to a reference probe. Calibration temperatures can be stored and programmed in for automatic temperature cycling and data logging. The latest technology is used to deliver superior stability, greater accuracy and best performance.

*World's First*  
**Multi-Functional**  
**Baths**  
**SIX FUNCTIONS**



**ISOCAL - 6**  
**LIQUID & DRY BLOCK**



Black Body



Block Bath



Ice Bath



ITS - 90



Liquid Bath

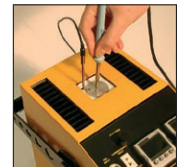

Surface Sensor

ADVANCED SPECIFICATIONS		
Parameter	Model	
	Hyperion 4936	Drago 4934
Temperature Range	-25°C to 140°C <sup>1</sup>	30°C to 250°C <sup>2</sup>
Stability	Liquid Bath: ±0.005°C Dry Block: ±0.005°C	Liquid Bath: ±0.01°C Dry Block: ±0.01°C
Resolution	0.001°C Over Full Range	0.001°C Over Full Range
Display Accuracy <sup>3</sup>	0.15°C	0.15°C
Uniformity - Radial, Liquid Bath Mode	<0.009°C	<0.007°C
Uniformity - Axial, Liquid Bath Mode (40mm)	<0.011°C	<0.013°C
Uniformity - Radial, Dry Block Mode (Between Wells)	<0.008°C	<0.008°C
Uniformity - Axial, Dry Block Mode (40mm)	<0.040°C	<0.040°C
Heating Time	-20°C to 140°C: 40 Mins	30°C to 250°C: 40 Mins
Cooling Time	140°C to 20°C: 90 Mins 20°C to -25°C: 80 Mins	250°C to 30°C: 90 Mins
Calibration Volume	65 x 160mm	
Standard Insert	8 x 8mm Pockets and 2 x 4.5mm, all 157mm deep	
Input Channels	Full range of inputs and accuracies with calibration options available online	
PC Interface	Ethernet - supporting software and USB Host	
Power	115Vac or 230Vac 50/60Hz 200 Watts	115Vac or 230Vac 50/60Hz 1000 Watts
Dimensions	335H x 208W x 307D mm	
Weight	12kg	8kg

(1) In ambient of 20°C: Minimum Temperature is 45°C Below Ambient, Absolute Minimum -35°C

(2) In ambient of 20°C

(3) Dry Block Mode only: Comparing 4.5mm Well to Controller Display Value.

## ADVANCED FEATURES

- Digital Display of Set and Nominal Block Temperature
- PC Interface: Ethernet (Optional Serial Legacy Kit available)
- Two channel thermostat testing
- Inbuilt Temperature Indicator for Reference Probe and two universal inputs for PRT, Thermocouple or Process inputs and a further Thermocouple input
- Automatic Temperature Cycling - Create Programs from front panel or on PC with included software
- Data Logging with export to USB
- Offset Elimination - block can follow reference input
- Speaks five languages: English, French, German, Italian and Spanish
- In Built Web Server
- Tamper Proof Data - in accordance with 21CFR, Part 11.

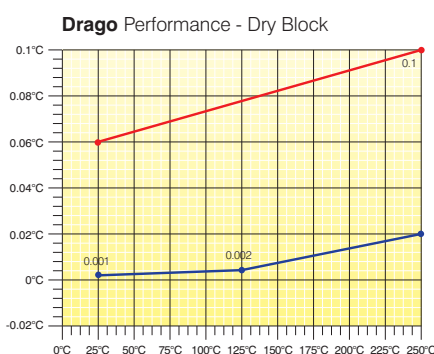
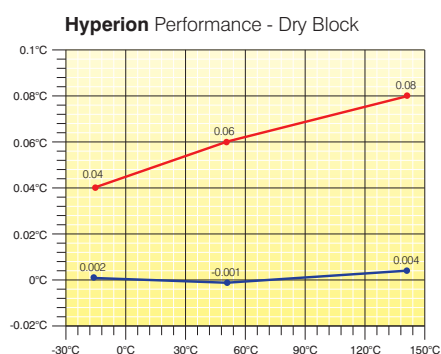

■ Audit Calibration (Similar Sensors)

■ Radial Homogeneity

See Evaluation Reports for full details  
<http://www.isotech.co.uk>

# Isocal-6 Ultimate Flexibility - Hyperion & Drago

Calibrate all sensor types - Thermocouples, PRT's, Thermistors, Thermostats, Infrared, Surface Sensors...

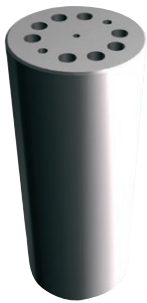

**1 Dry Block Mode with Inserts**  
**936-06-01a** Standard Insert is:  
 8 x 8mm + 2 x 4.5mm all 157mm Deep.  
 All Inserts have a 4mm tapped hole to  
 suit supplied extractor tool.

**Alternative Inserts**

**936-06-01b** Blank Insert  
**936-06-01c** Special Insert.  
*Contact Isotech with  
 your requirements.*

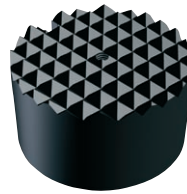

**4 Infrared Calibration Mode with  
 Blackbody Target**  
**936-06-03** Use optional Probe  
 936-14-61DB.



**5 Surface Sensor Calibration with  
 Surface Sensor Kit**  
**936-06-04** Includes an Insert and  
 an angled platinum  
 resistance thermometer.



**2 Stirred Liquid Mode  
 with Liquid Container Kit**  
 Hyperion and Drago are ready to use  
 as portable liquid baths. To get started  
 simply add a suitable liquid into the unit  
 and you are ready to go. We include a  
 magnetic stirrer, probe basket and  
 sealing lid.  
 Add a Liquid Container Kit to facilitate  
 rapid change of liquids, the liquid now  
 goes into the removable container  
 rather than directly into the block.  
 Includes container, magnetic stirrer,  
 probe guide and sealing cap.  
**936-06-02**

**3 Stirred Ice Bath Mode with Liquid  
 Container Kit**  
 Uses same liquid kit to provide 0°C  
 reference as a stirred ice bath.

**Additional Accessories for use with  
 the above kit**

**Thermometer Support Kit**  
**936-06-08** Supports up to eight  
 thermometers into liquid.  
 Suits probes 5mm - 8mm  
 in diameter.

**Oils**  
**936-06-07** C10 Oil -35°C - 140°C 1L  
**580-06-09** C20 Oil 20°C - 200°C 1L  
**915/09** VH Oil 150°C - 250°C 1L

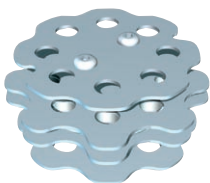

**6 ITS-90 Fixed Point Cells**  
**B8** 0.01°C Water Triple Point  
 Cell (Hyperion)  
**17401 Slim** 29.7648°C Gallium Slim  
 Cell  
**936-06-09** Cell Holder Assembly



**Standard Probe**  
**935-14-61/DB** Platinum Resistance  
 Thermometer.  
 Probe diameter 4mm,  
 recommended pocket  
 size 4.5mm.



**Current Loop Interface**  
**935-06-161** 24VDC Power Supply  
 and Terminal Box.  
 Powers 4-20mA  
 Current Transmitters  
 with 4mm terminal posts  
 for easy connection.



**Carrying Case**  
**931-22-111** Sturdy case with room  
 for accessories.  
 Features wheels and  
 pull out handle.



**Calibration**  
 Includes three point traceable calibration  
 certificate for block temperature

**UKAS Calibration**  
 Recommended: Options for block  
 temperature and reference  
 thermometer inputs (simulation).  
 Legally traceable in more than 70  
 countries.

# The world's leading National Metrology Institutes choose Isotech - shouldn't you?

**Isotech manufacture the widest range of temperature calibration equipment from hand held thermometers to Primary Standards. With Isotech solutions you can expand your equipment no matter what the requirement.**

Isotech have been pioneering the latest developments in Temperature Metrology for more than 30 years, benefit from our know how, experience and global network.

## Hyperion & Drago Benefits

### Excellent Uniformity

- The Hyperion uses specially designed thermoelectric heat pumps positioned in four heating / cooling zones around the block.

The Drago has four heating areas evenly distributed for optimum uniformity.

### Excellent Stability

- The Advanced model automatically compensates for power fluctuations and features advanced PID algorithms with digital filtering to deliver world class control and superior stability.

### Calibrate More Sensors

- Industry leading 65mm diameter well allows for larger probes, or a greater number of smaller probes allowing you to calibrate more sensors.

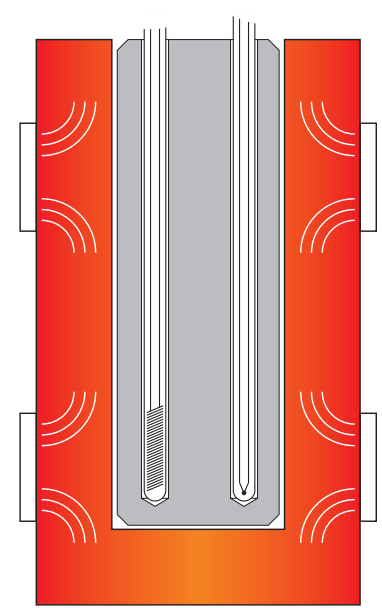

Four distributed heat/cooling zones for optimum uniformity



The Isotech website includes ISOCAL-6 video demonstrations

## Calibrating with an Advanced Model

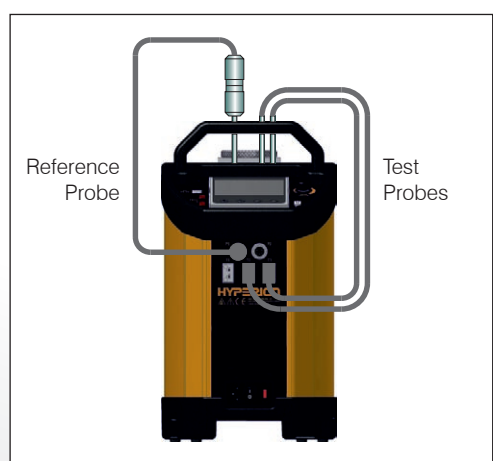

### ADVANCED Model

The ADVANCED model includes an indicator with channels for both a reference probe and units under test. This allows best practice calibration with established traceability and uncertainty. Advanced features include automatic temperature cycling and logging.

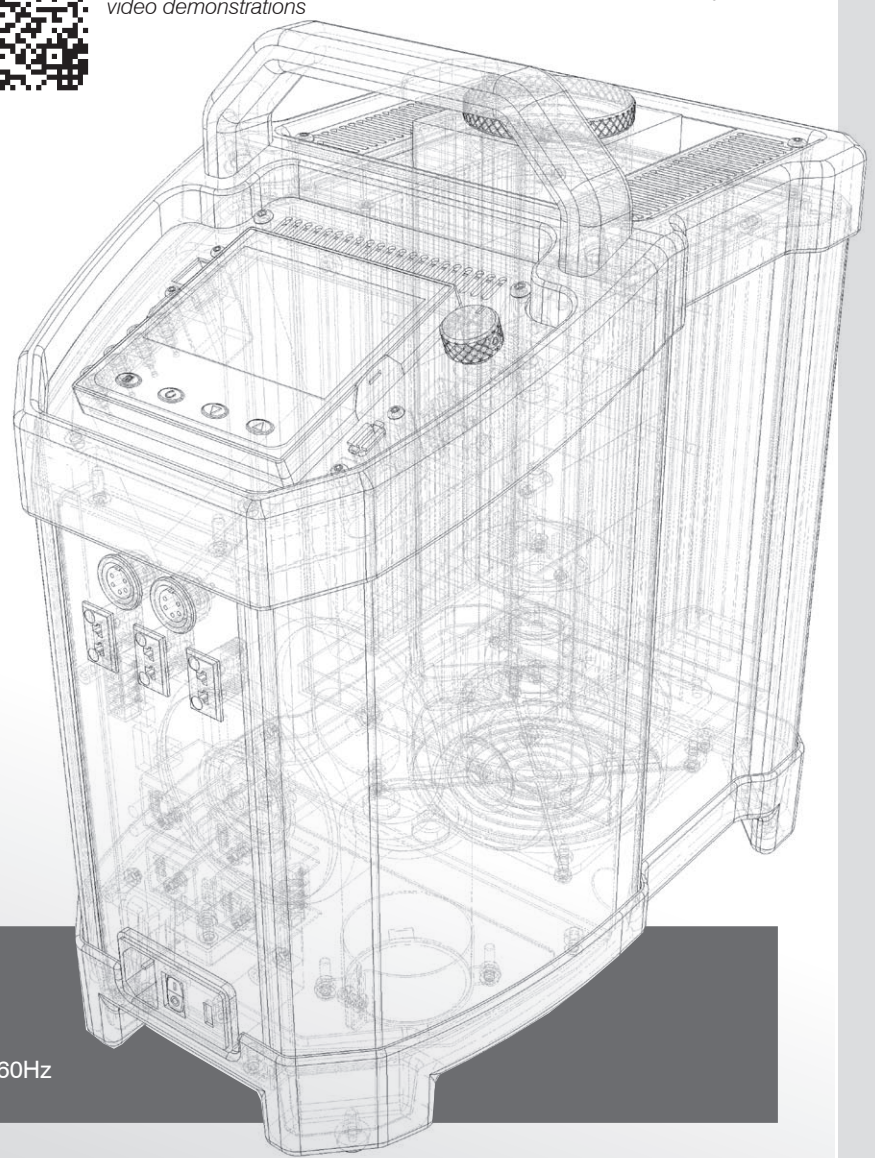

- How To Order**
- 1 - Select Desired Options and Accessories
  - 2 - Supply Voltage:  
Specify either 115Vac 50/60hz or 230Vac 50/60Hz

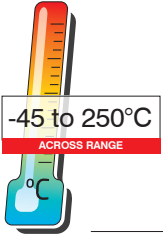

**NEW**

# ISOCAL - 6 Range Advanced Europa Venus Calisto

- Advanced Features including inbuilt three channel temperature indicator
- 35 x 160mm Calibration Volume
- Multi-Function - Six Modes including Dry Block and Liquid Bath

These models will calibrate temperature probes from -45°C to 250°C with unrivalled flexibility. As a traditional Dry Block, several thermometers can be quickly calibrated.

Accessories are available to convert to a stirred liquid bath, for surface sensor calibration, to calibrate infrared thermometers and even to use as an ITS-90 Fixed Point System with calibration uncertainties as small as 0.0005°C.

These award winning calibrators are easy to use - see the pictorial guide.

These new ADVANCED models offer a wide range of features and benefits including an independent three channel temperature indicator allowing test probes to be compared to a reference probe. Calibration temperatures can be stored and programmed in for automatic temperature cycling and data logging. The latest technology is used to deliver superior stability, greater accuracy and best performance.

Isotech is a world leader in temperature calibration, providing many nations with their Primary Standards and operates a full scale UKAS accredited calibration laboratory. We can offer a range of calibration options to meet your requirements.

Benefit from our experience and understanding in calibration at all levels, our evaluation reports, our tutorials and uncertainty calculations.



<http://www.isotech.co.uk/industrial/>

These models meet the calibration capacity requirements of EURAMET/cg-13/v.01, "EA Guidelines on the Calibration of Temperature Block Calibrators, formerly EA10/13. accuracy and best performance.

*World's First  
Multi-Functional  
Baths*  
**SIX FUNCTIONS**



## ISOCAL - 6 LIQUID & DRY BLOCK



Black Body



Block Bath



Ice Bath



ITS - 90



Liquid Bath

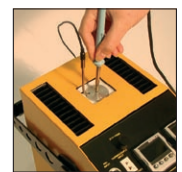

Surface Sensor



ADVANCED SPECIFICATIONS			
Parameter	Model		
	Europa 4520	Venus 4951	Calisto 4953
Temperature Range	-45°C to 140°C <sup>(1)</sup>	-35°C to 140°C <sup>(2)</sup>	30°C to 250°C <sup>(3)</sup>
Stability	Dry Block / Liquid Bath: ±0.01°C, Ice Bath: ±0.001°C		±0.025°C
	Blackbody: ±0.3°C, Surface Sensor: ±0.5°C, ITS-90 Cells: ±0.0005°C		
Display Resolution	0.001°C over whole range		0.01°C over whole range
Accuracy <sup>(4)</sup>	0.15°C	0.15°C	0.25°C
Uniformity - Between Wells Dry Block Mode (Radial)	<0.008°C	<0.008°C	<0.02°C at 250°C
Uniformity - Lower 40mm (Axial) Dry Block Mode	<0.040°C	<0.040°C	<0.25°C
Uniformity - Radial Liquid Bath Mode	<0.02°C	<0.02°C	<0.011°C at 250°C
Uniformity - Lower 40mm (Axial) As Liquid Bath	<0.026°C	<0.026°C	<0.02°C at 250°C
Heating Time	-30°C to 140°C: 15 Mins	-30°C to 140°C: 15 Mins	25°C to 250°C: 15 Mins
Cooling Time	140°C to 0°C: 15 Mins	140°C to 0°C: 15 Mins	250°C to 30°C: 25 Mins
Calibration Volume	35 x 160mm		
Standard Insert	6 pockets, 2 x 4.5mm, 2 x 6.4mm, 1 x 8.0mm, 1 x 9.5mm diameter, all 157mm deep		
Insert Types	Choice of Three - See Accessories		
PC Interface	Ethernet - supporting software and USB Host		
Dimensions	335H x 208W x 307D mm		
Power	300 Watts	150 Watts	300 Watts
Voltage	115Vac or 230 Vac 50/60Hz		
Weight	14kg	10.2kg	8kg

(1) In ambient of 20°C: Minimum Temperature is 65°C Below Ambient, Absolute Minimum -55°C

(2) In ambient of 20°C: Minimum Temperature is 55°C Below Ambient, Absolute Minimum -45°C

(3) In ambient of 20°C

(4) Dry Block Mode only: Comparing 4.5mm Well to Controller Display Value.

ADVANCED FEATURES
■ Digital Display of Set and Nominal Block Temperature
■ PC Interface: Ethernet (Optional Serial Legacy Kit available)
■ Two channel thermostat testing
■ Inbuilt Temperature Indicator for Reference Probe and two universal inputs for PRT, Thermocouple or Process inputs and a further Thermocouple input
■ Automatic Temperature Cycling - Create Programs from front panel or on PC with included software
■ Data Logging with export to USB
■ Offset Elimination - block can follow reference input
■ Speaks five languages: English, French, German, Italian and Spanish
■ In Built Web Server
■ Tamper Proof Data - in accordance with 21CFR, Part 11.

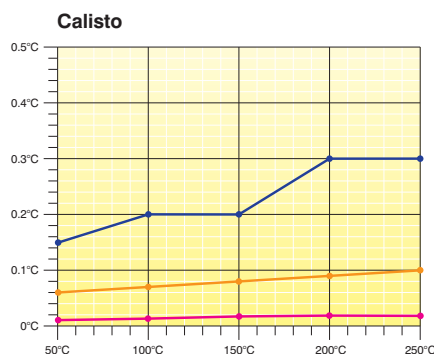
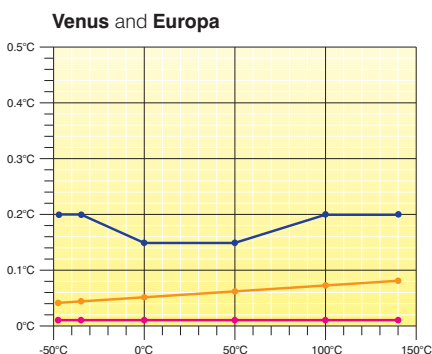

- Uncertainty with Reference Probe with optional UKAS Calibration
- Audit Calibration: Method comparing a PRT to UKAS Calibrated model
- Radial Homogeneity. Use for similar probes and external indicator

See Evaluation Reports for full details  
<http://www.isotech.co.uk>

# Isocal-6 Ultimate Flexibility - Europa, Venus & Calisto

Calibrate all sensor types - Thermocouples, PRT's, Thermistors, Thermostats, Infrared, Surface Sensors...



## 1 Dry Block Mode with Inserts

**951-02-15** An Insert is included: (2 x 4.5mm, 2 x 6.4mm, 1 x 8mm & 1 x 9mm) x 157mm Deep.

All Inserts have a 4mm tapped hole to suit supplied extractor tool.

### Alternative Inserts



**951-06-07** Alternative Insert type B 13mm, 10mm, 8mm, 5mm and 3.5mm dia. holes, all 157mm deep



**951-06-08** Alternative Insert type C 8mm, 6 x 6.5mm dia. holes, all 157mm deep

**951-02-15a** Blank Insert without pockets for local machining. Includes M4 tapped hole for supplied extractor tool.

**951-02-15c** Custom insert. Isotech can provide custom drilled pockets, minimum of 3mm separation between holes. *Contact Isotech with your requirements.*



## 2 Stirred Liquid Mode with Liquid Container Kit

Allows liquid bath use, includes container, magnetic stirrer, probe guide and sealing cap. **951-06-01**

## 3 Stirred Ice Bath Mode with Liquid Container Kit

Uses same liquid kit to provide 0°C reference as a stirred ice bath (Not Calisto)

### Additional Accessories for use with the above kit

#### Thermometer Support Kit

**951-06-03** Allows three thermometers to be suspended in the bath, including liquid in glass types

#### Oils

**520-05-01** C10 Oil -35°C – 140°C 0.1L

**951-06-06** C20 Oil 20°C – 200°C 0.1L

**953-04-01** VH Oil 150°C – 250°C 0.1L

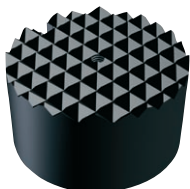
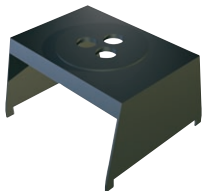

## 4 Infrared Calibration Mode with Blackbody Target

**951-06-04** Use optional Probe 934-14-82/DB placed in the auxiliary block pocket for use as a reference.



## 5 Surface Sensor Calibration with Surface Sensor Kit

**951-06-02** Includes angled platinum resistance thermometer.



## 6 ITS-90 Fixed Point Cells

**17724M** Slim Mercury Cell (Europa Only).

**B8** Water Triple Point Cell (Venus and Europa)

**17401M** Slim Gallium Cell (Europa, Venus and Calisto)



## Standard Probe

**935-14-82/DB** Platinum Resistance Thermometer.

Probe diameter 4mm, recommended pocket size 4.5mm. Angled head feature avoids sensors in block.



## Current Loop Interface

**935-06-161** 24VDC Power Supply and Terminal Box. Powers 4-20mA Current Transmitters with 4mm terminal posts for easy connection.



## Carrying Case

**931-22-111** Sturdy case with room for accessories. Features wheels and pull out handle.

# The world's leading National Metrology Institutes choose Isotech - shouldn't you?

Isotech manufacture the widest range of temperature calibration equipment from hand held thermometers to Primary Standards. With Isotech solutions you can expand your equipment no matter what the requirement.

Isotech have been pioneering the latest developments in Temperature Metrology for more than 30 years, benefit from our know how, experience and global network.

## Europa, Venus & Calisto Benefits

### Excellent Uniformity

- The specially designed thermoelectric heat pumps positioned in four heating / cooling zones around the block.

## Calibrating with an Advanced Model

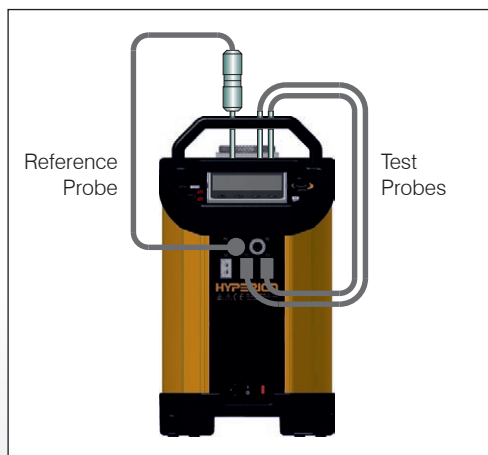

### ADVANCED Model

The ADVANCED model includes an indicator with channels for both a reference probe and units under test. This allows best practice calibration with established traceability and uncertainty. Advanced features include automatic temperature cycling and logging.

#### How To Order

- 1 - Select Desired Options and Accessories
- 2 - Supply Voltage:  
Specify either 115Vac 50/60hz or 230Vac 50/60Hz

### Excellent Stability

- The Advanced models automatically compensate for power fluctuations and feature advanced PID algorithms with digital filtering to deliver world class control and superior stability.

### ISOCAL-6 Benefit

- Isotech introduced the ISOCAL-6 as the worlds first multi-functional bath with 6 operating modes.



The Isotech website includes ISOCAL-6 video demonstrations

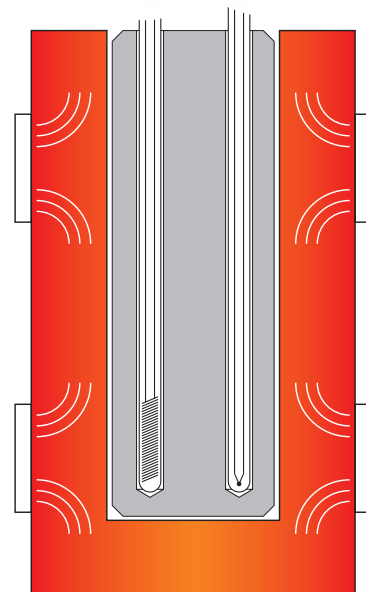

Four distributed heat/cooling zones for optimum uniformity

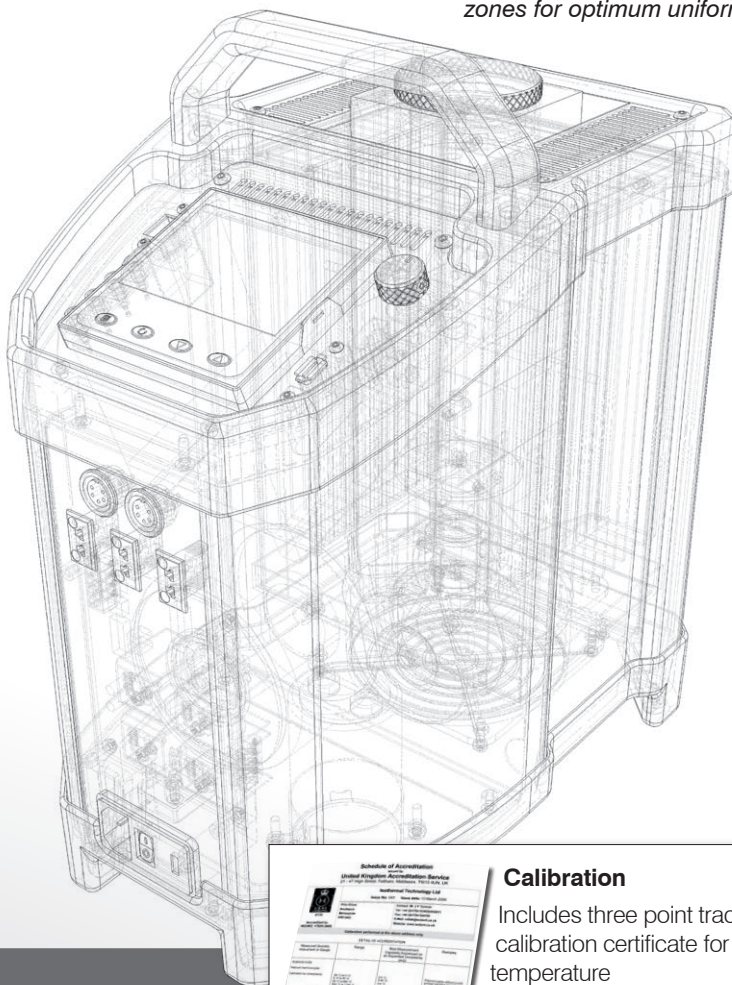

#### Calibration

Includes three point traceable calibration certificate for block temperature

#### UKAS Calibration

Recommended: Options for block temperature and reference thermometer inputs (simulation). Legally traceable in more than 70 countries.



35 to 660°C

# Dry Block Calibrator

## **NEW** Advanced Jupiter

- Advanced Features including inbuilt three channel temperature indicator
- 35 x 160mm Calibration Volume
- Fast with wide operating range

The Jupiter Dry Block range offers industry-leading performance in an easy to use portable package - ideal for the calibration of thermocouples and platinum resistance thermometers. It has been designed for fast heating and cooling for convenient field use. For flexibility surface sensor and infrared thermometer accessories can be added.

The standard insert can hold up to six thermometers. For larger blocks see the Gemini and Medusa range.

These award winning calibrators are easy to use - see the pictorial guide. The new ADVANCED model offers a wide range of features and benefits including an independent three channel temperature indicator allowing test probes to be compared to a reference probe. Calibration temperatures can be stored and programmed in for automatic temperature cycling and data logging. The latest technology is used to deliver superior stability, greater accuracy and best performance.

Isotech is a world leader in temperature calibration, providing many nations with their Primary Standards and operates a full scale UKAS accredited calibration laboratory. We can offer a range of calibration options to meet your requirements.

Benefit from our experience and understanding in calibration at all levels, our evaluation reports, our tutorials and uncertainty calculations.

These models meet the calibration capacity requirements of EURAMET/cg-13/v.01, "EA Guidelines on the Calibration of Temperature Block Calibrators, formerly EA10/13.



<http://www.isotech.co.uk/industrial/>

## Calibrating with an Advanced Model

### ADVANCED Model

The ADVANCED model includes an indicator with channels for both a reference probe and units under test. This allows best practice calibration with established traceability and uncertainty. Advanced features include automatic temperature cycling and logging.

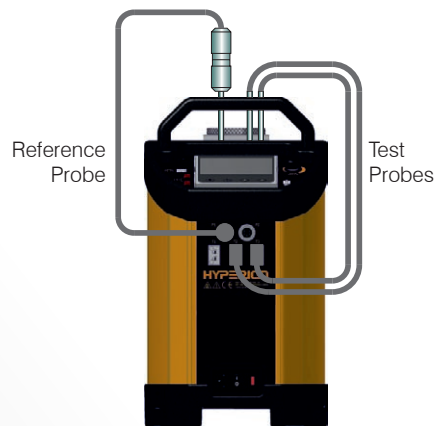

ADVANCED SPECIFICATIONS	
Parameter	Model
	<b>Jupiter 4852</b>
Temperature Range	35°C to 660°C
Stability over 30 minutes	At 50°C ±0.02°C At 250°C ±0.02°C At 650°C ±0.03°C
Display Resolution	0.01°C over whole range
Blackbody Source	±0.3°C
Surface Sensor Calibrator	±0.5°C
Cools from 650°C to 150°C	in 60 minutes
Heats from 30°C to 650°C	in 20 minutes
Best Performance	See Graph
Calibration volume	35mm diameter by 148mm deep
Standard Insert	6 pockets, 2 x 4.5mm, 2 x 6.4mm, 1 x 8.0mm, 1 x 9.5mm diameter, all 140mm deep
Indicator units	°C, °F, K
PC Interface	Ethernet - supporting software and USB Host
Power	115Vac or 230Vac 50/60Hz 1000 Watts
Dimensions	335H x 208W x 307D mm
Weight	8.5kg

### ADVANCED FEATURES



- Digital Display of Set and Nominal Block Temperature
- PC Interface: Ethernet (Optional Serial Legacy Kit available)
- Two channel thermostat testing
- Inbuilt Temperature Indicator for Reference Probe and two universal inputs for PRT, Thermocouple or Process inputs and a further Thermocouple input
- Automatic Temperature Cycling - Create Programs from front panel or on PC with included software
- Data Logging with export to USB
- Offset Elimination - block can follow reference input
- Speaks five languages: English, French, German, Italian and Spanish
- In Built Web Server
- Tamper Proof Data - in accordance with 21CFR, Part 11.

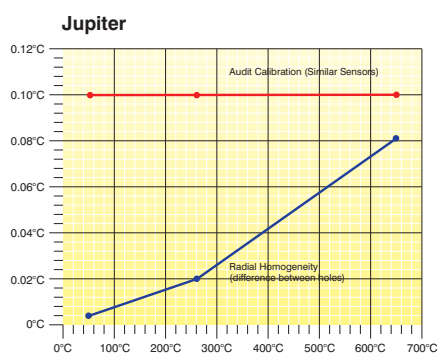

- Audit Calibration (Similar Sensors)
- Radial Homogeneity

See Evaluation Reports for full details  
<http://www.isotech.co.uk>

# Accessories - Jupiter



**Metal Block Insert 852-07-11**  
Standard Insert included.  
Size: 2 x 4.5mm, 2 x 6.4mm, 1 x 8mm and 1 x 9.5mm all 140mm deep

**Alternative Inserts**



**852-09-03** Alternative Insert type B  
13mm, 10mm, 8mm, 5mm and 3.5mm diameter holes, all 140mm deep



**852-09-04** Alternative Insert type C  
8mm, 6 x 6.5mm diameter holes, all 140mm deep

**852-07-07** Blank Insert *without pockets for local machining*. Includes M4 tapped hole for supplied extractor tool.

**852-07-07C** Custom Insert. Isotech can provide custom drilled pockets, minimum of 3mm separation between holes. *Contact Isotech with your requirements.*



**Air Cooling 853-04-02** For use with an air supply this accessory allows air to be blown into the block for rapid cooling.



**Standard Probe 935-14-72/DB** Platinum Resistance Thermometer for use up to 660°C.  
Probe diameter 6mm, recommended pocket size 6.5mm.



**Current Loop Interface 935-06-161** 24VDC Power Supply and Terminal Box. Powers 4-20mA Current Transmitters with 4mm terminal posts for easy connection.

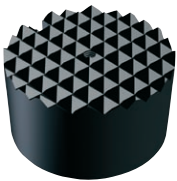

**Blackbody Kit 852-09-05** Includes a Blackbody target and Sensor.



**Carrying Case 931-22-111** Sturdy case with room for accessories. Features wheels and pull out handle.



**Surface Sensor Kit 852-07-15** Includes angled thermocouple.



**Calibration**  
Includes three point traceable calibration certificate for block temperature

**UKAS Calibration**  
Recommended: Options for block temperature and reference thermometer inputs (simulation).  
Legally traceable in more than 70 countries.

# The world's leading National Metrology Institutes choose Isotech - shouldn't you?

**Isotech manufacture the widest range of temperature calibration equipment from hand held thermometers to Primary Standards. With Isotech solutions you can expand your equipment no matter what the requirement.**

Isotech have been pioneering the latest developments in Temperature Metrology for more than 30 years, benefit from our know how, experience and global network.

## Jupiter Benefits

- The Jupiter calibration block features uniform heating with a custom wound heater over an extended length of the block. The block itself is made from copper which has a very high thermal conductivity; much

superior to the aluminium bronze alloys used elsewhere. A propriety process is used to protect the copper from oxidising. This combination of materials and expert knowledge delivers superior performance.

### 660°C Operation

- The Jupiter ADVANCED operates to 660°C maximum; matched to the upper limit of the high temperature Isotech Semi Standard Platinum Resistance Thermometers. This allows maximum accuracy with no risk to exceeding the temperature limit of the PRT. This gives greater accuracy than extending the range beyond 660°C and having to use an inferior thermometer or thermocouple.

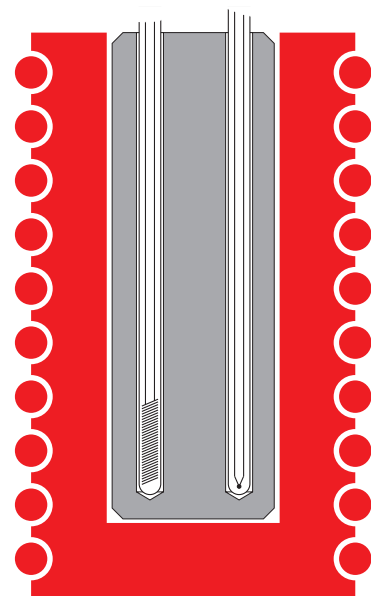

*Superior uniformity by using copper block with extended length heating*

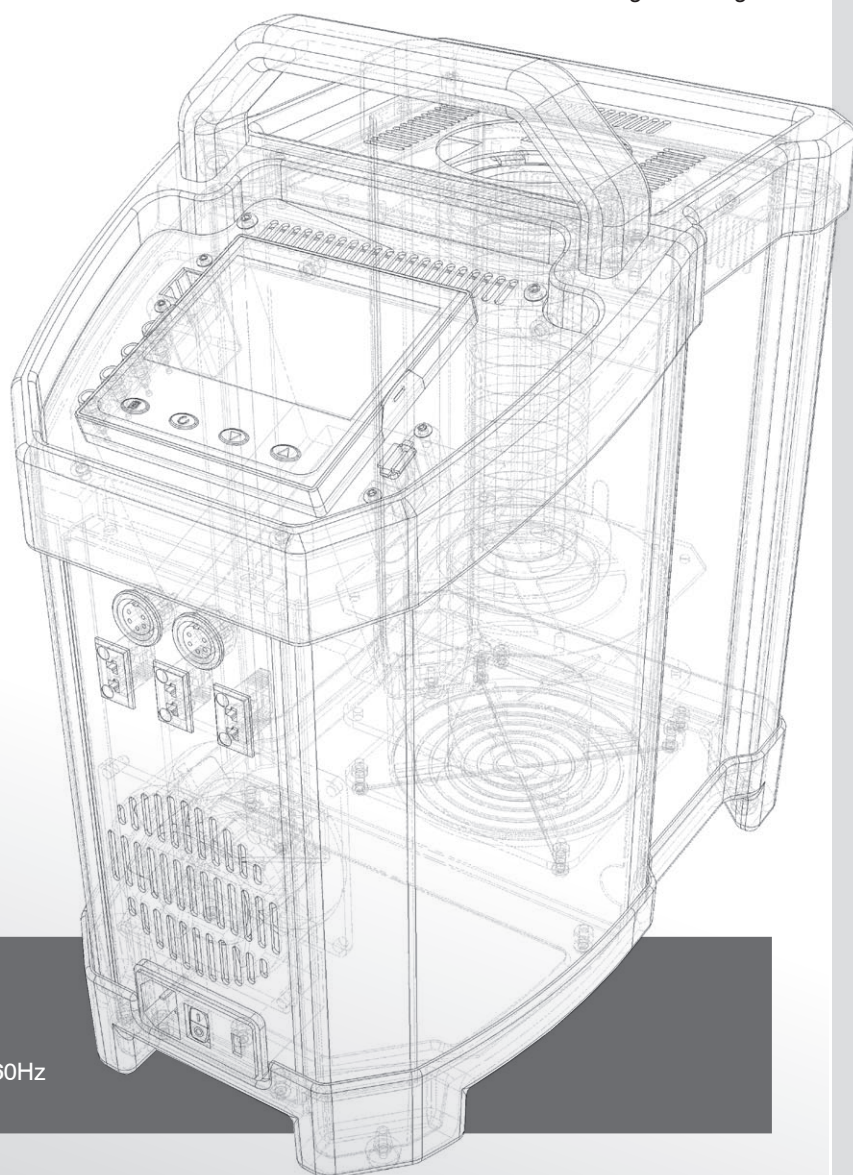

### How To Order

- 1 - Select Desired Options and Accessories
- 2 - Supply Voltage:  
Specify either 115Vac 50/60hz or 230Vac 50/60Hz



35 to 700°C

# Dry Block Calibrator

## **NEW** Advanced Gemini

- Advanced Features including 3 channel reference thermometer
- Large High Capacity Blocks - fixed or removable 64 x 160mm
- Calibrate Large Diameter Probes

The Gemini range of Dry Blocks have high capacity allowing a large number of probes to be calibrated together. They are also suitable to accept large diameter probes with the block volume of a nominal 64 x 160mm.

Whilst the large block takes longer to heat and cool than the Jupiter and Fast-Cal models it can calibrate thermocouples, resistance thermometers, thermostats and sensors that are too large for the smaller blocks.

Available with a fixed block with four 8mm and four 19.5mm pockets or the LRI version which has a removable block. With the LRI model blocks can be drilled to custom configurations.

This new ADVANCED model offers a wide range of features and benefits including an independent three channel temperature indicator, allowing test probes to be compared to a reference probe. Calibration temperatures can be stored and programmed in for automatic temperature cycling and data logging. The latest technology is used to deliver superior stability, greater accuracy and best performance.

Isotech is a world leader in temperature calibration, providing many nations with their Primary Standards and operates a full scale UKAS accredited calibration laboratory. We can offer a range of calibration options to meet your requirements.

Benefit from our experience and understanding in calibration at all levels, our evaluation reports, our tutorials and uncertainty calculations.



<http://www.isotech.co.uk/industrial/>

These models meet the calibration capacity requirements of EURAMET/cg-13/v.01, "EA Guidelines on the Calibration of Temperature Block Calibrators, formerly EA10/13.

## Calibrating with an Advanced Model

### ADVANCED Model

The ADVANCED model includes an indicator with channels for both a reference probe and units under test. This allows best practice calibration with established traceability and uncertainty. Advanced features include automatic temperature cycling and logging.

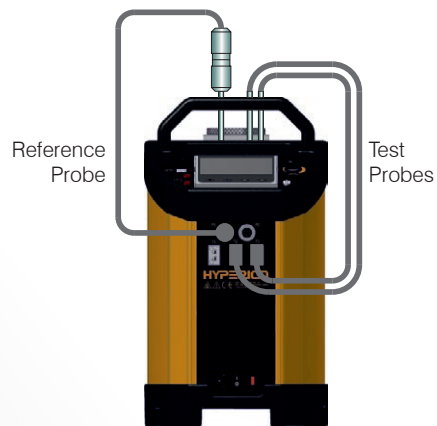



ADVANCED SPECIFICATIONS				
Parameter	Model: Gemini 4857			
	550	700	500LRI	700LRI
Temperature Range	35°C to 550°C	50°C to 700°C	35°C to 550°C	50°C to 700°C
Absolute stability over 30 minutes	At 35°C ±0.05°C At 250°C ±0.05°C At 550°C ±0.05°C At 700°C ±0.05°C		At 35°C ±0.02°C At 250°C ±0.03°C At 550°C ±0.04°C At 700°C ±0.05°C	
Display Resolution	0.01°C over whole range			
Cools from 550°C to 275°C from 550°C to 60°C	35 minutes 345 minutes	- -	132 minutes 420 minutes	- -
Heats from 30°C to 550°C from 50°C to 700°C	35 minutes	- 110 minutes	60 minutes	120 minutes
Best Performance	See Graph			
Calibration volume	65mm diameter x 160mm deep			
Standard Insert	Fixed Block 4 x 8mm pockets 4 x 19.5mm pockets All 160mm deep		8 x 8mm pockets all 154mm deep	
Indicator units	°C, °F, K			
PC Interface	Ethernet - supporting software and USB Host			
Voltage	115Vac or 230Vac 50/60Hz			
Power	600 Watts		1000 Watts	
Dimensions	335H x 208W x 307D mm			
Weight	8.5kg	14kg	8.5kg	18kg

### ADVANCED FEATURES

- Digital Display of Set and Nominal Block Temperature
- PC Interface: Ethernet (Optional Serial Legacy Kit available)
- Two channel thermostat testing
- Inbuilt Temperature Indicator for Reference Probe and two universal inputs for PRT, Thermocouple or Process inputs and a further Thermocouple input
- Automatic Temperature Cycling - Create Programs from front panel or on PC with included software
- Data Logging with export to USB
- Offset Elimination - block can follow reference input
- Speaks five languages: English, French, German, Italian and Spanish
- In Built Web Server
- Tamper Proof Data - in accordance with 21CFR, Part 11.

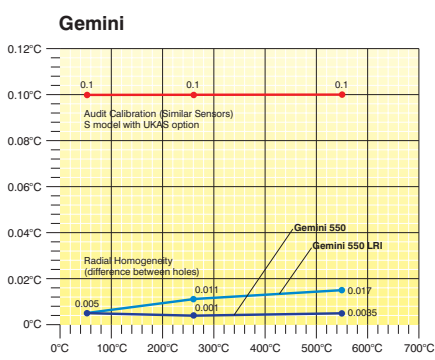

- Audit Calibration (Similar Sensors)
- Radial Homogeneity

See Evaluation Reports for full details  
<http://www.isotech.co.uk>

# Accessories - Gemini



## Metal Block Sleeves

### Gemini<sup>PLUS</sup> 550

Set of four Sleeves to suit the block. Optional single hole sizes 4, 6, 8, 10, 12, 14mm diameter all 150mm deep.

**857-07-01** Undrilled sleeves for local machining.

**857-07-03** 1 sleeve with 2 holes 4.5mm x 150mm deep.

### Gemini<sup>PLUS</sup> 700

Set of four Sleeves to suit the block. Optional single hole sizes 4, 6, 8, 10, 12, 14mm diameter all 150mm deep.

**857-07-02** Blank sleeves for local machining.

**857-07-04** 1 sleeve with 2 holes 4.5mm x 150mm deep.

**Note:** The use of sleeves will introduce an additional thermal gradient into the block. This can be avoided by using the LRI model with a block drilled for specific probes.



## Removable Inserts

### Gemini<sup>PLUS</sup> 550 LRI

**976-07-01a** Included as Standard Removable insert with eight 8mm pockets

**976-07-01b** Blank Insert Insert without pockets for local machining

**976-07-01c** Custom Insert Contact Isotech with your requirements



### Gemini<sup>PLUS</sup> 700 LRI

**976-07-02a** Included as Standard Removable block with eight 8mm pockets

**976-07-02b** Blank Insert Insert without pockets for local machining

**976-07-02c** Custom Insert Contact Isotech with your requirements



## Calibration

Includes three point traceable calibration certificate for block temperature

### UKAS Calibration

Recommended: Options for block temperature and reference thermometer inputs (simulation).

Legally traceable in more than 70 countries.



## Current Loop Interface

**935-06-161** 24VDC Power Supply and Terminal Box. Powers 4-20mA Current Transmitters with 4mm terminal posts for easy connection.



## Standard Probe

**935-14-72/DB** Platinum Resistance Thermometer for use up to 650°C.

**935-14-63** Type N Thermocouple for use up to 700°C.



## Carrying Case

**931-22-111** Sturdy case with room for accessories. Features wheels and pull out handle.

# The world's leading National Metrology Institutes choose Isotech - shouldn't you?

Isotech manufacture the widest range of temperature calibration equipment from hand held thermometers to Primary Standards. With Isotech solutions you can expand your equipment no matter what the requirement.

Isotech have been pioneering the latest developments in Temperature Metrology for more than 30 years, benefit from our know how, experience and global network.

## Gemini Benefits

- The Gemini has a large block with sufficient mass to accommodate larger sensors, a larger number of sensors. The fixed block has four 19.5mm pockets and four 8mm pockets.
- The LRI model with its removable block can be custom drilled. The larger blocks take longer to heat and cool then the Jupiter but the larger size allows larger probes than can be accommodated in a 35mm block. We can also provide custom blocks to simulate applications, allowing probes that would otherwise be unsuitable for Dry Block calibration to be evaluated.

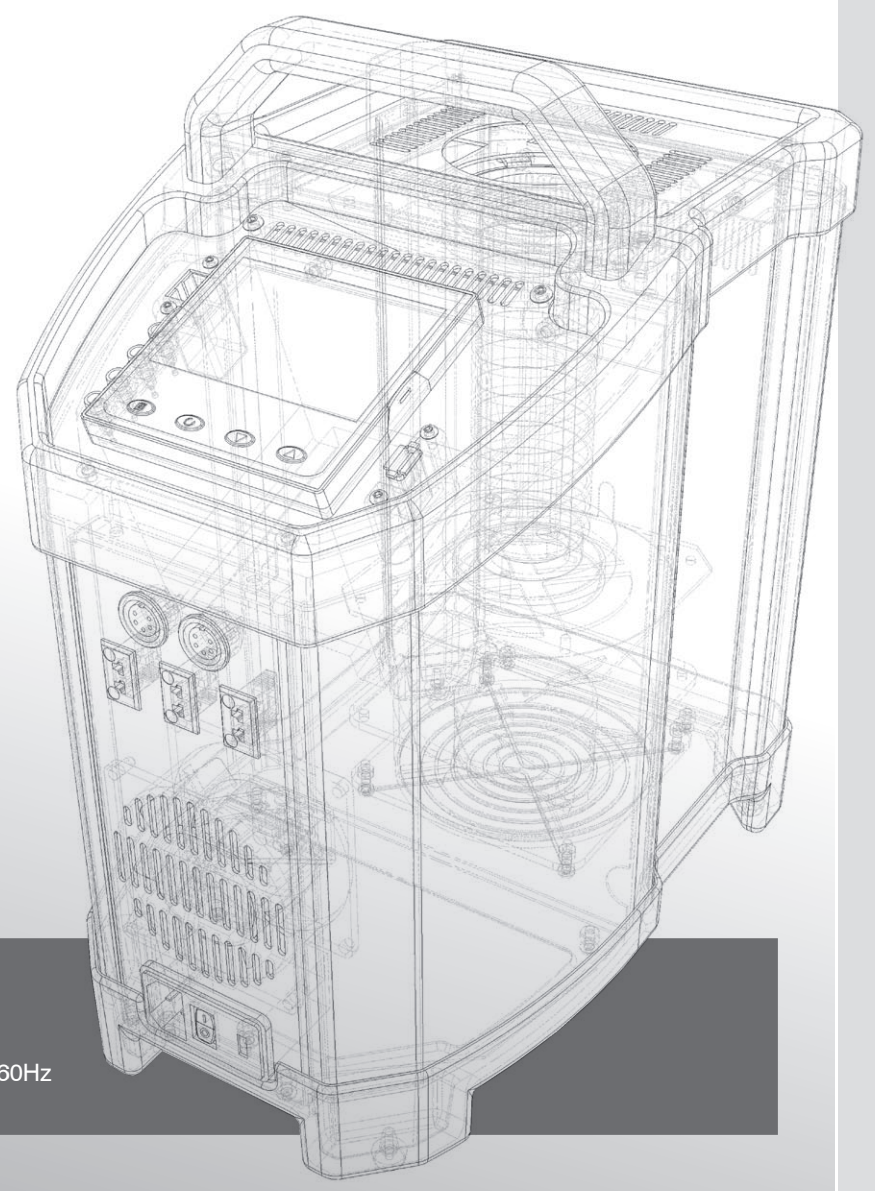

**How To Order**  
1 - Select Desired Options and Accessories  
2 - Supply Voltage:  
Specify either 115Vac 50/60hz or 230Vac 50/60Hz



150 to 1200°C

**NEW**

# Dry Block Calibrator Advanced Pegasus

- Advanced Features including 3 channel reference thermometer
- High Temperature Thermocouple Calibration Furnace
- 33.5 x 130mm Calibration Volume

The Pegasus range offers extreme high temperature calibration in an easy to use portable package - ideal for the calibration of high temperature thermocouples. It has been designed for fast heating and finds applications in the glass, electrical power, automotive and material processing industries.

This new ADVANCED model offers a wide range of features and benefits including an independent three channel temperature indicator, allowing test probes to be compared to a reference probe. Calibration temperatures can be stored and programmed in for automatic temperature cycling and data logging. The latest technology is used to deliver superior stability, greater accuracy and best performance.

A Blackbody target can be added for the calibration of infrared thermometers.

The standard insert has four 8mm pockets 80mm deep. The metal insert is strategically placed beneath 50mm of insulation to provide optimal performance over the radiant temperature range.

The optional Blackbody target is used with a specially angled Type R thermocouple that sits immediately behind the target area.

Benefit from our experience and understanding in calibration at all levels, our evaluation reports, our tutorials and uncertainty calculations.

Isotech is a world leader in temperature calibration, providing many nations with their Primary Standards and



<http://www.isotech.co.uk/industrial/>

operates a full scale UKAS accredited calibration laboratory. We can offer a range of calibration options to meet your requirements.

## Calibrating with an Advanced Model

### ADVANCED Model

The ADVANCED model includes an indicator with channels for both a reference probe and units under test. This allows best practice calibration with established traceability and uncertainty. Advanced features include automatic temperature cycling and logging.

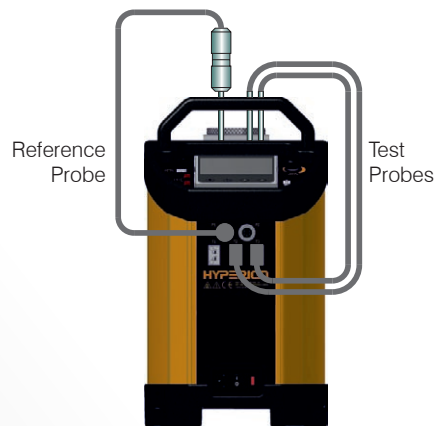

ADVANCED SPECIFICATIONS	
Parameter	Model
	<b>Pegasus 4853</b>
Temperature Range	150°C to 1200°C
Absolute stability over 30 minutes	At 150°C ±0.1°C At 1200°C ±0.2°C Blackbody Source ±0.3°C
Display Resolution	0.1°C over whole range
Cools from 1200°C to 800°C 1200°C to 200°C	in 50 minutes* in 180 minutes* *substantially reduced by the cooling adaptor
Heating Rate	25°C / minute
Calibration volume	33.5mm diameter by 130mm deep
Standard Insert	4 x 8mm Pockets all 80mm deep + 50mm top insulator
Indicator units	°C, °F, K
PC Interface	Ethernet - supporting software and USB Host
Power	115Vac or 230Vac (50 / 60 Hz) 800 Watts
Dimensions	335H x 208W x 307D mm
Weight	13kg

### ADVANCED FEATURES

- Digital Display of Set and Nominal Block Temperature
- PC Interface: Ethernet (Optional Serial Legacy Kit available)
- Two channel thermostat testing
- Inbuilt Temperature Indicator for Reference Probe and two universal inputs for PRT, Thermocouple or Process inputs and a further Thermocouple input
- Automatic Temperature Cycling - Create Programs from front panel or on PC with included software
- Data Logging with export to USB
- Offset Elimination - block can follow reference input
- Speaks five languages: English, French, German, Italian and Spanish
- In Built Web Server
- Tamper Proof Data - in accordance with 21CFR, Part 11.

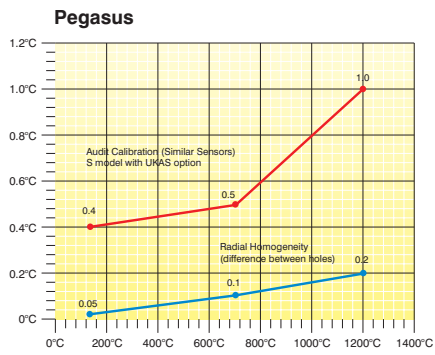

■ Audit Calibration (Similar Sensors)  
■ Radial Homogeneity

See Evaluation Reports for full details  
<http://www.isotech.co.uk>

# Accessories - Pegasus



### Metal Block Insert

**853-06-01** Standard Insert Included  
Four 8mm pockets.  
Pocket depth 80mm +  
50mm insulator.  
Effective depth 130mm.

**853-06-02** Blank Insert  
*Insert without pockets for  
local machining*

**853-06-02b** Custom Insert  
*Contact Isotech with  
your requirements*



### Air Cooling

**853-04-02** For use with a compressor  
this accessory allows air  
to be blown into the  
block for rapid cooling.



### Ceramic Insulators

**853-06-04** Spare insulation pack  
Includes 2 x standard  
tops and 2 x standard  
bottoms.



### Blackbody Kit

**853-06-03** Includes a Blackbody  
target and Sensor



### Calibration

Includes three point traceable calibration  
certificate for block temperature

### UKAS Calibration

Recommended: Options for block  
temperature and reference thermometer  
inputs (simulation).

Legally traceable in more than 70  
countries.



### Current Loop Interface

**935-06-161** 24VDC Power Supply  
and Terminal Box.  
Powers 4-20mA  
Current Transmitters  
with 4mm terminal posts  
for easy connection.



### Carrying Case

**931-22-111** Sturdy case with room  
for accessories.  
Features wheels and  
pull out handle.



### Standard Probe

**935-14-91** Type R Platinum  
Thermocouple for use  
up to 1200°C.

# The world's leading National Metrology Institutes choose Isotech - shouldn't you?

## Pegasus Benefits

The Pegasus features a small tube furnace to allow operation to 1200°C in a portable case. With a ceramic furnace construction temperature gradients are larger than with lower temperature metal blocks.

The Isotech furnace benefits over other designs by using a specially wound furnace tube assembly. They are manufactured in our factory with the turns concentrated at the ends of the furnace, where the heat losses are

greatest. This gives an improved temperature profile and lower uncertainty.

Insulators are provided for the top and bottom of the furnace which further improve temperature uniformity.

The effective immersion depth is 130mm, 80mm in the metal insert and then a further 50mm in the furnace tube.

*Benefit from Isotech's design and experience*

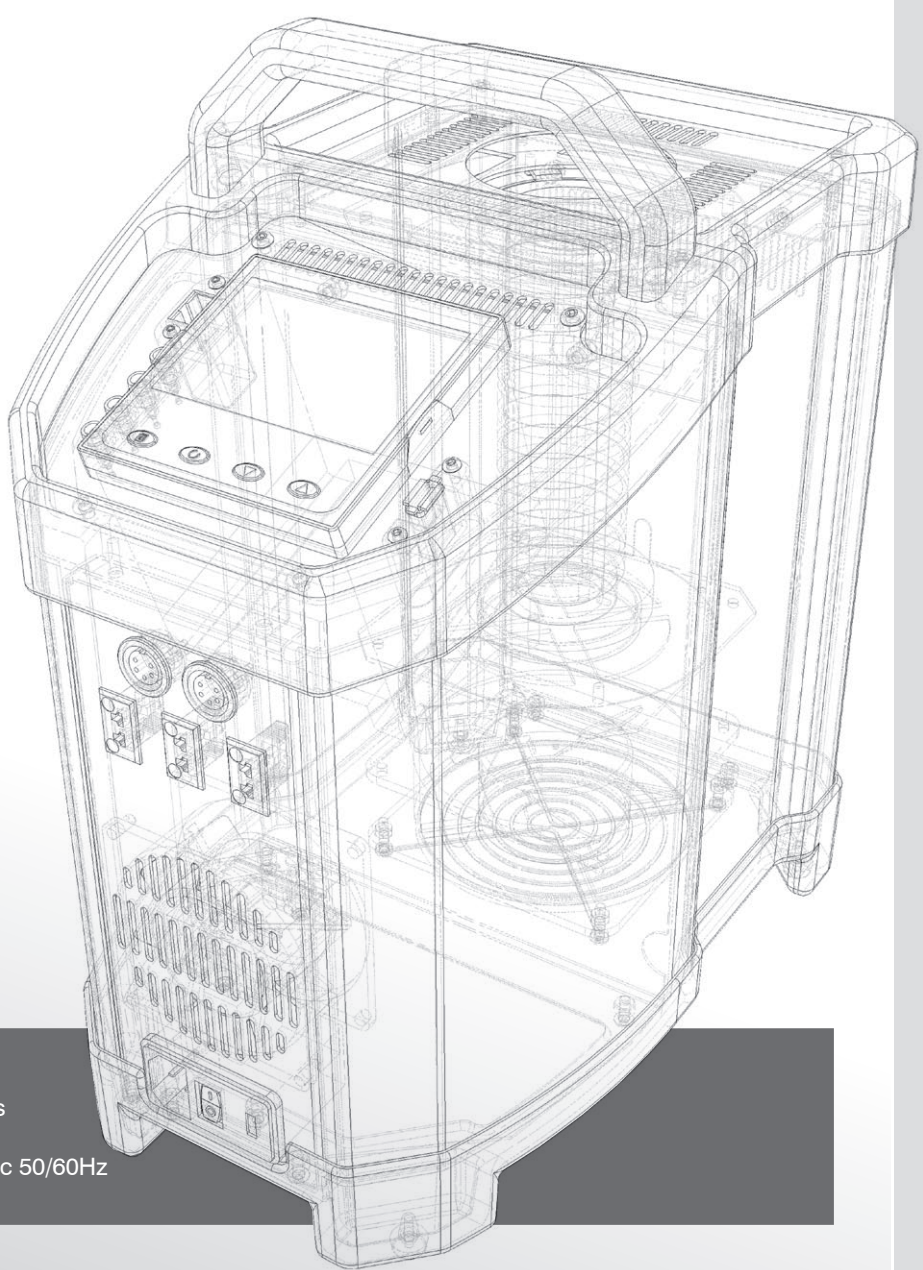
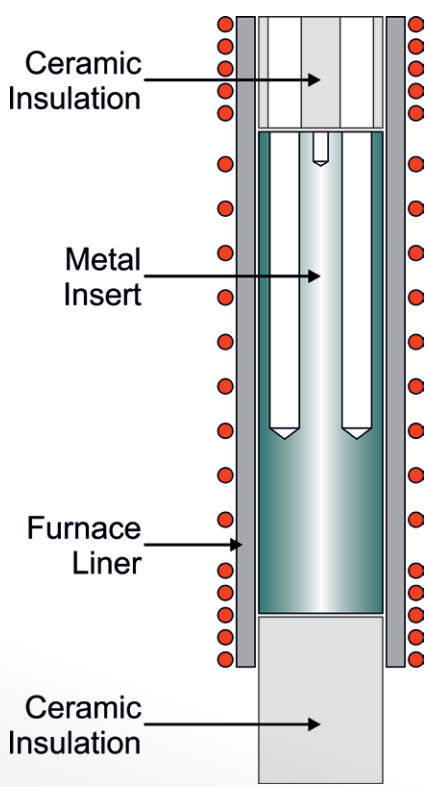

- How To Order**
- 1 - Select Desired Options and Accessories
  - 2 - Supply Voltage:  
Specify either 115Vac 50/60hz or 230Vac 50/60Hz

# Isotech Fast Calibrators

## ■ Quick-Cal & Fast-Cal



**Working on site?**

**Having to carry the device?**

Then choose our handheld Quick Cal or fast response Fast-Cal Calibrators.

Together they span the range -35°C to 650°C and have been designed to be both rugged and light weight.



# Isotech True Temperature Indicators

## ■ milliK



The milliK is a very high accuracy thermometer - capable of performance to 0.003°C with SPRTs and PRTs and also enables high accuracy measurement from thermistors, thermocouples and even 4-20 mA process inputs. It can be expanded to have up to 33 flexible inputs.

In addition to low uncertainty measurements from Reference Standards and Industrial sensor measurement the milliK can control Isotech temperature sources, sequencing through a programmable list of temperature set points and log data to internal memory or a USB drive.

## ■ TTI-10



The TTI-10 is a high accuracy handheld temperature indicator with two platinum resistance thermometer inputs.

It is particularly suitable as a portable reference thermometer to use alongside Isotech temperature calibrators.

The TTI-10 is also suited for high accuracy measurements in industrial and scientific applications.

## ■ Industrial Reference Probes



These industrial platinum resistance thermometers and thermocouples are ideal for field and lab use.

Suitable for use as working standards in Dry Blocks and Liquid Baths or as high accuracy probes for our range of True Temperature Indicators.

They cover a temperature range from -200°C to 1300°C.



Edificio Antalia  
Albasanz, 16  
28037 MADRID  
Tel. 91 567 97 00  
Fax: 91 570 26 61

[www.alavaingenieros.com](http://www.alavaingenieros.com)

Torre Mapfre-Vila Olímpica  
Marina, 16 - Planta 11 - C2  
08005 BARCELONA  
Tel. 93 459 42 50  
Fax: 93 459 42 62

[alava@alava-ing.es](mailto:alava@alava-ing.es)

The ISOTECH logo in white text on a red background.

The Source for Calibration Professionals

Telephone: +44 (0)1704 543830

Fax: +44 (0)1704 544799 Email: [info@isotech.co.uk](mailto:info@isotech.co.uk) Web: [www.isotech.co.uk](http://www.isotech.co.uk)  
Isothermal Technology Limited Pine Grove, Southport, Merseyside PR9 9AG England

