

B2520



IMPERX: Technically superior products, full tech support, rapid-response customer care. "Bobcat 2.0" adds many new features, lens control, more memory and enhanced image quality. Each easy to use Bobcat is supported by IMPERX professionals.

INTERFACES AVAILABLE:

Resolution
 Sensor
 Sensor Format

Pixel Size
 Frame Rate Standard Clock
 Frame Rate Overclocked
 Maximum Frame Rate
 Minimum S/N Ratio
 Output Format

Analog Gain Control
 Black Level Control
 Digital Gain and Offset
 RGB Gain and Offset
 White Balance
 Shutter Speed
 Exposure Control
 Long Integration
 Regions of Interest (ROI)
 Binning H/V
 Trigger Inputs

Trigger Options

Trigger Modes

Double Trigger (PIV) Interframe
 External Inputs/Outputs
 Strobe Output
 RS232 Interface
 Pulse Generator
 Image Overlay
 Image Enhancement

Internal DDR Memory
 On Board FIFO (GEV & PoE)
 Gamma Correction
 Data Corrections

Minimum Illumination
 Lens Mount
 Video Iris Control
 Iris, Zoom Focus Control
 Supply Input Range
 Power Consumption
 Size – Width/Height
 Size – Length

Weight
 Vibration, Shock
 Environmental
 Humidity
 MTBF
 Regulatory

Camera Link® Base (PoCL), GigE Vision, PoE, CoaXPress
 2448 x 2050 (std.), 2456 x 2058 (max.)

ICX-625, CCD
 8.47mm (H) x 7.10mm (V), 11.016 diagonal
 2/3" optical format

3.45 μ m
 40 MHz / 11 fps
 64 MHz / 16 fps

50 fps
 53dB
 Mono CCD: 8, 10, 12, 14-bit (Single only)
 Color CCD: 8, 10, 12, RGB 24

Manual, Auto: 0 - 36dB 1024 steps
 Manual, 1024 steps
 Manual

Manual
 Manual, auto, off
 1 μ s/step, 1/80,000 to 1/11 sec (nom)
 Manual, auto, external

Up to 16 seconds
 7 ROIs, any line to any line, any pixel to any pixel
 1x, 2x, 3x, 4x, 8x (Independent for H & V)
 External (TTL via IN1/IN2), pulse generator,
 software, computer

Level, edge, pulse width, internal exposure,
 up to 16 seconds trigger delay, debounce
 Free-run, standard, double, fast, asynchronous,
 frame accumulation

Time: 200 nanoseconds
 2 IN, 2 OUT, user programmable
 2 strobes, programmable position and duration
 Yes, programmable
 Yes, programmable
 Optical center, programmable H & V lines
 Threshold, contrast enhancement, knee correction,
 horizontal flip, negative image, bit shift (+/- 7 places)

2Gb (256 MB)
 1Gb (128 MB)
 G=1.0, G=0.45, user upgradeable LUT
 Defective/hot pixel correction (static, dynamic),
 black level, vertical smear

1 Lux, F/ 1.4

C-Mount

Auto, programmable
 Manual, user programmable

12VDC (10V - 15V), 1.5 A inrush
 CLB 3.4 W, GEV 5.2W, PoE 6.3W, CXP TBD
 46mm (W) x 46mm (H) – Applies to all interfaces
 CLB 46.8mm (L), GEV 64.7mm (L), PoE 78.3mm (L),
 CXP 54.5mm (L)

CLB 159g, GEV 197g, PoE 298g, CXP 189g

100g (20-200) HZ XYZ, 1000g
 -40°C to +85°C Operating, -50°C to +90°C Storage

10% to 90% non-condensing

>660,000 hours @ 40°C (Telcordia SR-332)

FCC 15 part A, CE, RoHS

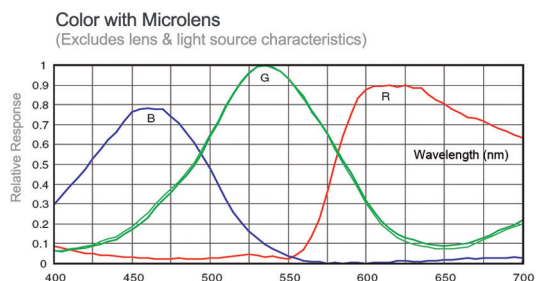
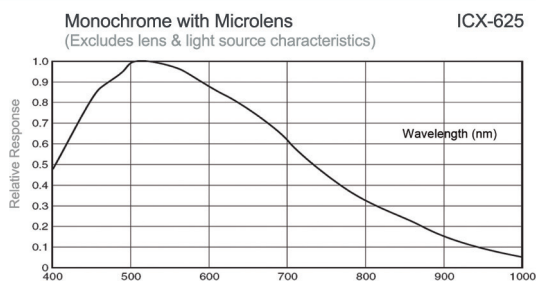

GigE Vision(Without PoE)

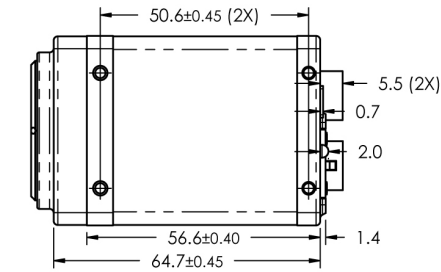

GigE Vision(With PoE)

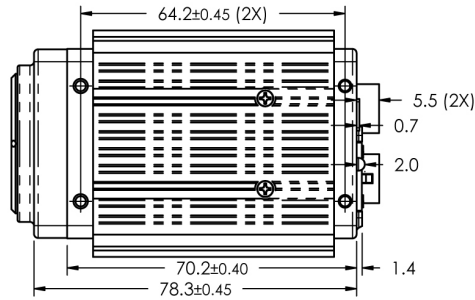

Camera Link

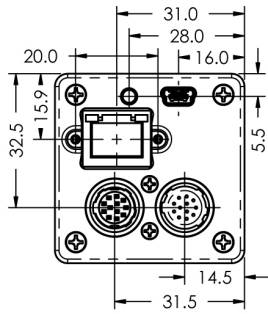
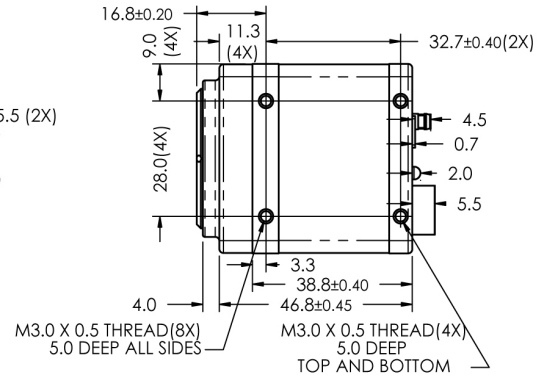

CENTER OF IMAGE IS NOMINALLY AT CENTER OF LENS

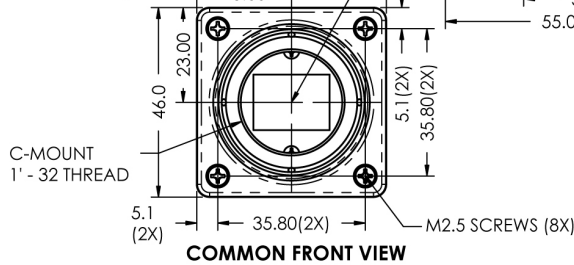
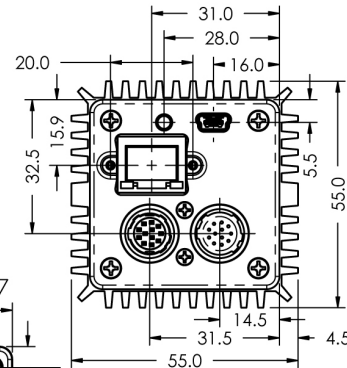

COMMON FRONT VIEW

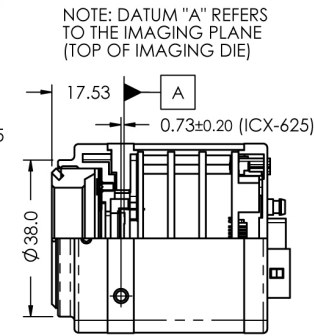

COMMON IMAGE PLANE DISTANCE

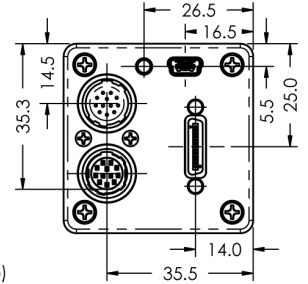

Hirose Connectors

Power and I/O Interface

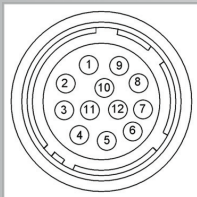

- | | |
|-------------------|-----------------|
| 1 12V DC Return * | 7 OUT1 Signal |
| 2 +12V DC* | 8 IN1 Signal |
| 3 IRIS VCC | 9 IN2 Signal |
| 4 IRIS Video | 10 IN1/2 Return |
| 5 IRIS Return | 11 Reserved |
| 6 OUT1/2 Return | 12 OUT2 Signal |

Connector: Hirose HR 10A- 10R- 12PB(71)
*Not connected for CXP

Lens Control/RS232

See manual for PIN information

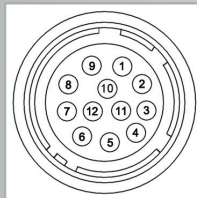

- | | |
|---------------|-------------|
| 1 IRIS Return | 7 FOCUS + |
| 2 IRIS VCC | 8 ZOOM - |
| 3 IRIS Video | 9 ZOOM + |
| 4 IRIS - | 10 UART_COM |
| 5 IRIS + | 11 UART_RX |
| 6 FOCUS - | 12 UART_TX |

Connector: Hirose HR 10A- 10R- 12SB(71)

CoaXPress

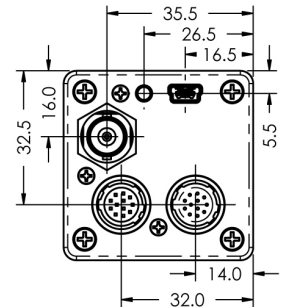
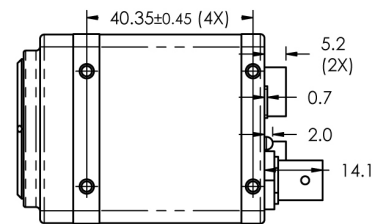

B2520 Ordering Information

Interfaces available

- Camera Link® Base (CLB)
- GigE Vision (GEV / PoE)
- CoaXPress (CXP)

Sensor types available

- Monochrome
- Bayer Color



WWW.IMPERX.COM

Accessories (Sold separately)

- PS12v04-Power Supply w/ 1 input and 1 output
- PS12v05-Power Supply (as above) and Video Iris



bobcat-B2520,Rev1