

# RIEGL VQ<sup>®</sup>-580

- **especially designed to measure on snow & ice**
- **high-accuracy ranging based on echo digitization and online waveform processing**
- **high laser repetition rate - fast data acquisition**
- **multiple target capability - unlimited number of targets**
- **perfectly linear scan lines**
- **compact, rugged and lightweight design**
- **electrical interfaces for GPS data string and Sync Pulse (1PPS)**
- **mechanical interface for IMU mounting**
- **integrated LAN-TCP/IP interface**

The V-Line<sup>®</sup> Airborne Laser Scanner **RIEGL VQ-580** provides high speed, non-contact data acquisition using a narrow near-infrared laser beam and a fast line scanning mechanism. High-accuracy laser ranging is based on **RIEGL's** unique echo digitization and online waveform processing, which allows achieving superior measurement results even under adverse atmospheric conditions, and the evaluation of multiple target echoes.

The scanning mechanism is based on a fast rotating multi-facet polygonal mirror, which provides fully linear, unidirectional and parallel scan lines.

The **RIEGL VQ-580** is a very compact and lightweight scanner, mountable in any orientation and even under limited space conditions on helicopters or UAVs. The instrument needs only one power supply and provides line scan data via the integrated LAN-TCP/IP interface. The binary data stream can easily be decoded by user-designed software making use of the available software library RIVLib.

#### Typical applications include

- **Glacier Mapping**
- **Snowfield Mapping**
- **Moist Grassland Mapping**
- **Corridor Mapping**

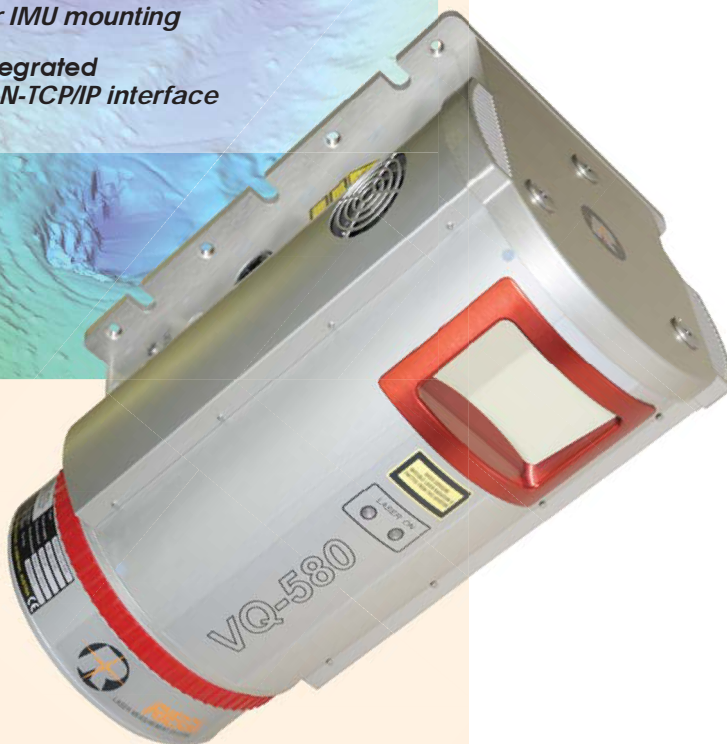

visit our website  
[www.riegl.com](http://www.riegl.com)

 **RIEGL**<sup>®</sup>  
LASER MEASUREMENT SYSTEMS

# Multiple-time-around Data Acquisition and Processing

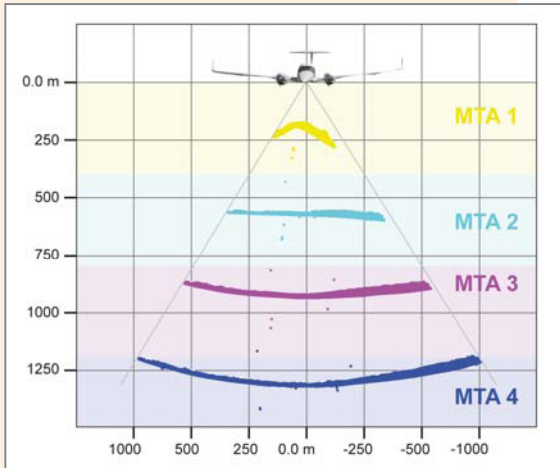

Fig. 1 Profile of scan data processed in MTA zones 1 to 4

In time-of-flight laser ranging a maximum unambiguous measurement range exists which is defined by the measurement repetition rate and the speed of light. When scanning at a pulse repetition rate of, e.g., 380 kHz, measurement ranges above approx. 395 m are ambiguous caused by an effect known as "Multiple-time-around" (MTA). In such case target echoes received may not be associated with their preceding laser pulses emitted any longer (MTA-zone 1), but have to be associated with their last but one (MTA-zone 2), or even last but two laser pulses emitted (MTA-zone 3), in order to determine the true measurement range.

Figure 1 gives an impression of ALS data where each single echo of a scan line is associated with each of its last four preceding laser shots emitted. Each single echo is represented by a measurement range calculated in MTA zone 1, 2, 3 and 4 respectively, but only one of the four realizations represents the true point cloud model of the scanned earth surface. The chosen example shows scan data correctly allocated in MTA zone 2, where the earth surface appears more or less flat in contrast to the typical spatial characteristics of incorrectly calculated ambiguous ranges in MTA zones 1, 3 and 4.

The RIEGL VQ-580 is capable of acquiring echo signals which arrive after a delay of more than one pulse repetition interval, thus allowing range measurements beyond the maximum unambiguous measurement range.

Unique techniques in high-speed signal processing and a novel modulation scheme applied to the train of emitted laser pulses permit range measurements without any gaps at any distance within the instrument's maximum measurement range. The specific modulation scheme applied to the train of emitted laser pulses avoids a total loss of data at the transitions between MTA-zones and retains range measurement at approximately half the point density.

The correct resolution of ambiguous echo ranges is accomplished using SDCImport in combination with the associated algorithm library RiMTA ALS, which does not require any further user interaction, and maintains fast processing speed for mass data production.

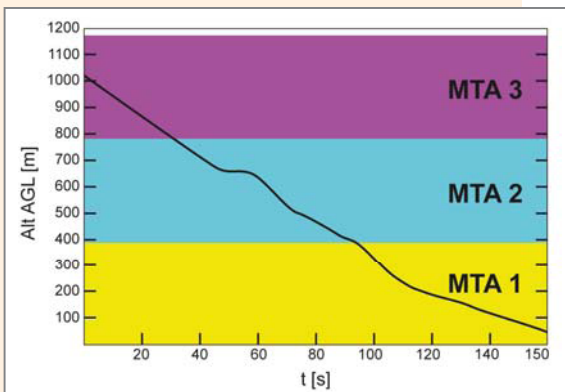
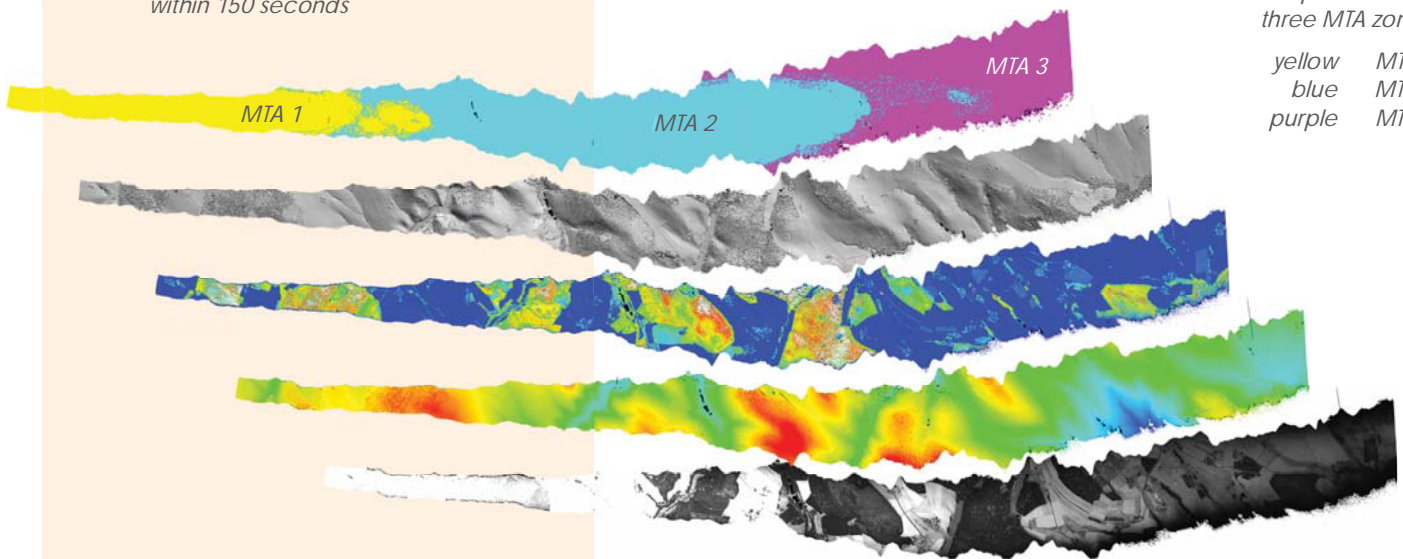

Fig. 2 Flight altitude above ground level descending from 1,000 m to 240 m within 150 seconds

One scan stripe transitting three MTA zones:

- yellow MTA 1
- blue MTA 2
- purple MTA 3



# Maximum Measurement Range & Point Density for RIEGL VQ<sup>®</sup>-580

PRR = 380 kHz

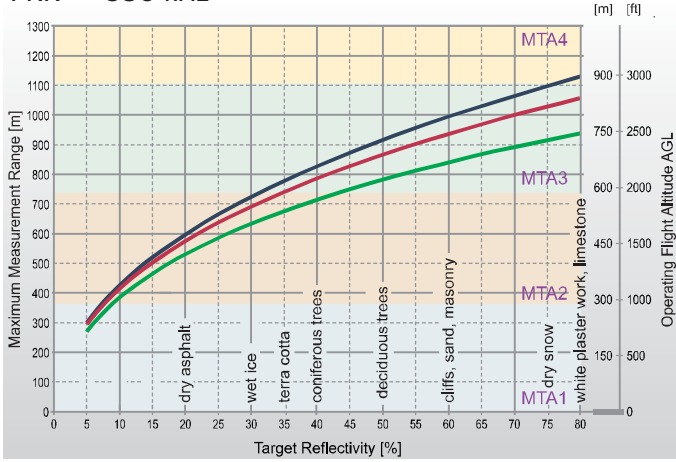

MTA1: no ambiguity / 1 transmitted pulse „in the air“  
 MTA2: 2 transmitted pulses „in the air“  
 MTA3: 3 transmitted pulses „in the air“  
 MTA4: 4 transmitted pulses „in the air“

@ visibility 23 km  
 @ visibility 15 km  
 @ visibility 8 km

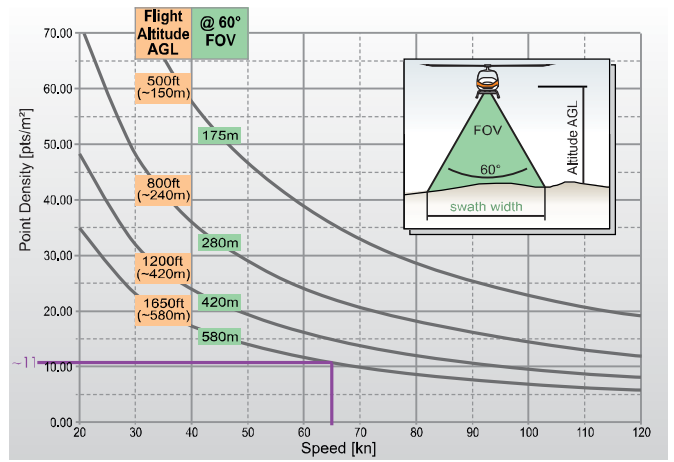

Example: VQ-580 at 380,000 pulses/second  
 Altitude = 1650ft AGL, Speed = 65 kn  
 Resulting Point Density ~ 11 pts/m<sup>2</sup>

PRR = 300 kHz

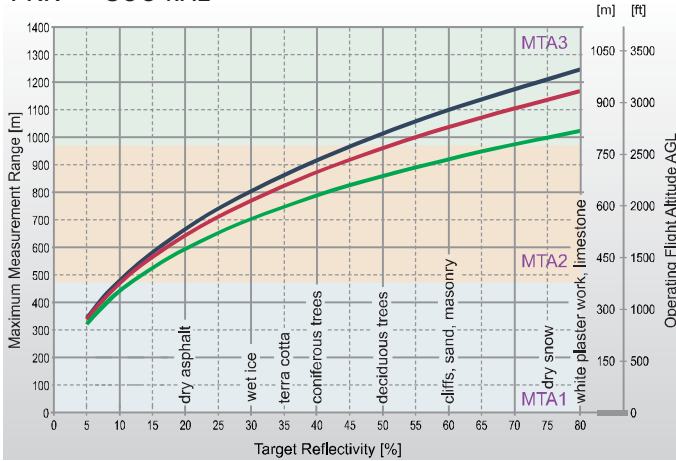

MTA1: no ambiguity / 1 transmitted pulse „in the air“  
 MTA2: 2 transmitted pulses „in the air“  
 MTA3: 3 transmitted pulses „in the air“

@ visibility 23 km  
 @ visibility 15 km  
 @ visibility 8 km

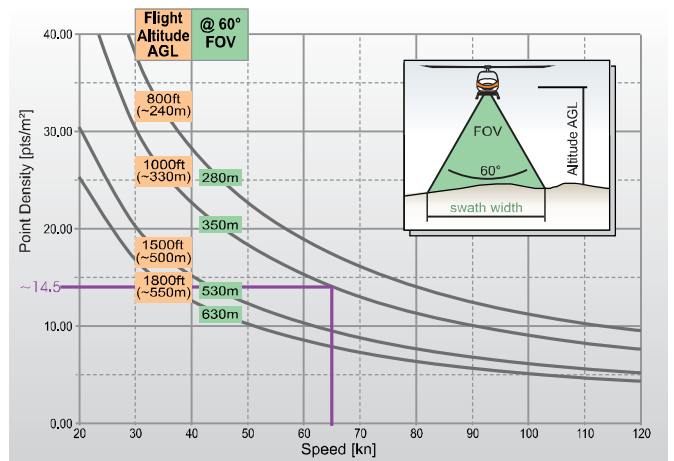

Example: VQ-580 at 300,000 pulses/second  
 Altitude = 1000ft AGL, Speed = 65 kn  
 Resulting Point Density ~ 14.5 pts/m<sup>2</sup>

The following conditions are assumed:  
 for the Operating Flight Altitude AGL

- ambiguity resolved by multiple-time-around (MTA) processing & flight planning
- target size <sup>3</sup> laser footprint
- scan angle 60°
- average ambient brightness
- roll angle +/- 5°

for MTA zones

- half the point density in MTA-transition zones
- width of transition between MTA-zone 1 and 2 approx. 45 m
- width of transition between MTA-zone 2 and 3 approx. 75 m

PRR = 200 kHz

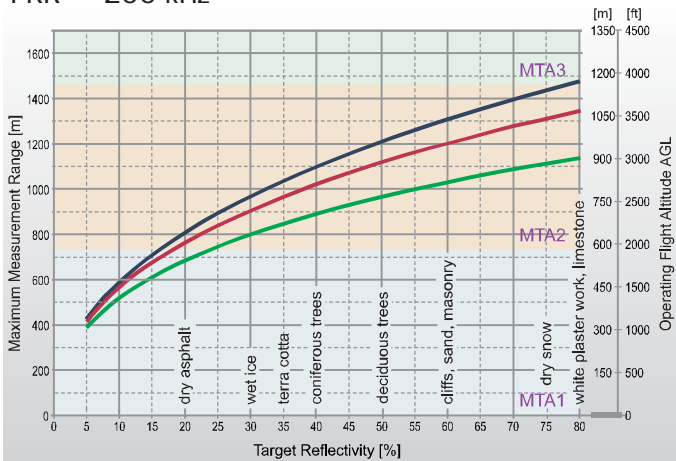

MTA1: no ambiguity / 1 transmitted pulse „in the air“  
 MTA2: 2 transmitted pulses „in the air“  
 MTA3: 3 transmitted pulses „in the air“

@ visibility 23 km  
 @ visibility 15 km  
 @ visibility 8 km

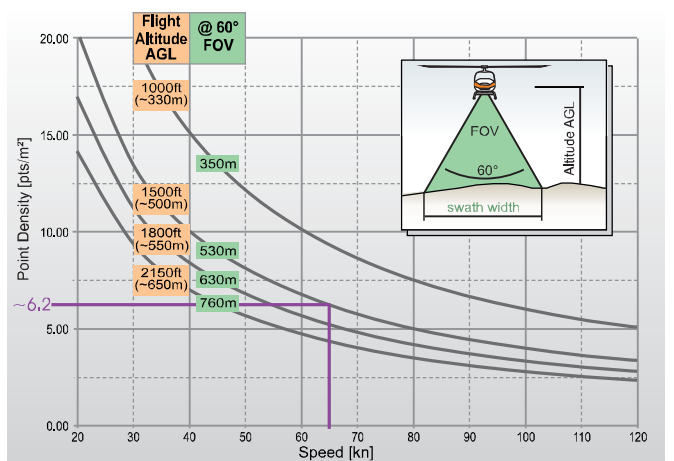

Example: VQ-580 at 200,000 pulses/second  
 Altitude = 1500ft AGL, Speed = 65 kn  
 Resulting Point Density ~ 6.2 pts/m<sup>2</sup>

# Maximum Measurement Range & Point Density for RIEGL VQ®-580

PRR = 150 kHz

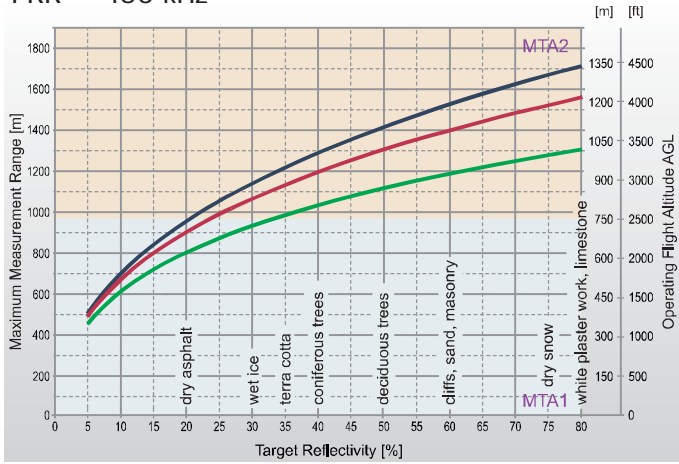

MTA1: no ambiguity / 1 transmitted pulse „in the cir“  
 MTA2: 2 transmitted pulses „in the cir“

— @ visibility 23 km  
 — @ visibility 15 km  
 — @ visibility 8 km

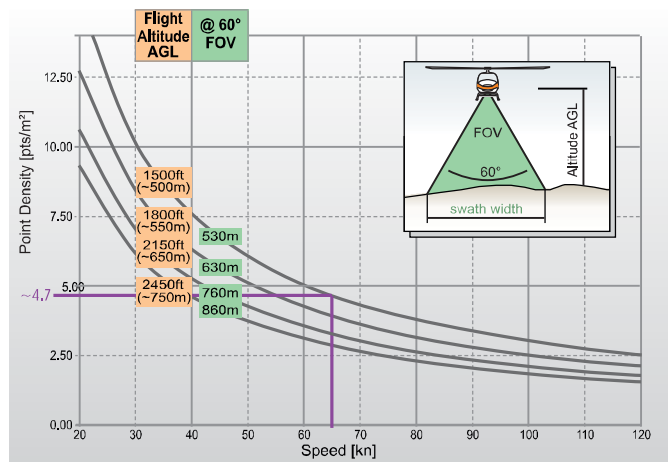

Example: VQ-580 at 150,000 pulses/second  
 Altitude = 1500ft AGL, Speed = 65 kn  
 Resulting Point Density ~ 4,7 pts/m<sup>2</sup>

PRR = 100 kHz

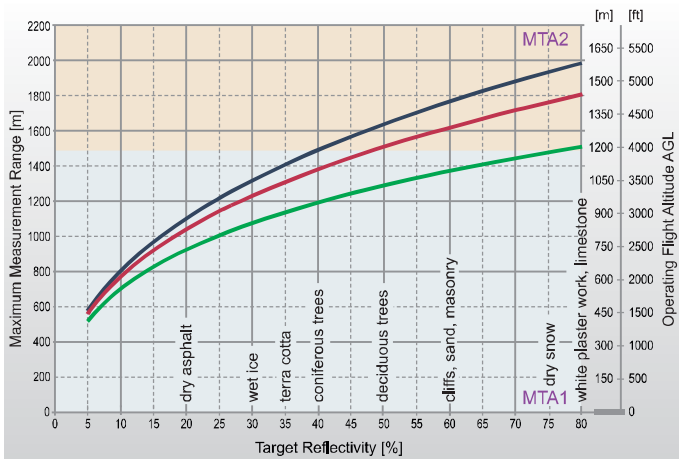

MTA1: no ambiguity / 1 transmitted pulse „in the cir“  
 MTA2: 2 transmitted pulses „in the cir“

— @ visibility 23 km  
 — @ visibility 15 km  
 — @ visibility 8 km

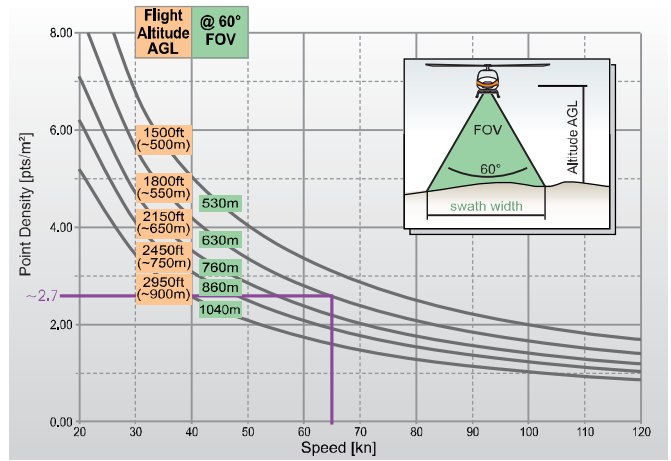

Example: VQ-580 at 100,000 pulses/second  
 Altitude = 1800ft AGL, Speed = 65 kn  
 Resulting Point Density ~ 2,7 pts/m<sup>2</sup>

The following conditions are assumed:  
 for the Operating Flight Altitude AGL

- ambiguity resolved by multiple-time-around (MTA) processing & flight planning
- scan angle 60°
- target size <sup>3</sup> laser footprint
- average ambient brightness
- roll angle +/- 5°

for MTA zones

- half the point density in MTA-transition zones
- width of transition between MTA-zone 1 and 2 approx. 45 m
- width of transition between MTA-zone 2 and 3 approx. 75 m

PRR = 50 kHz

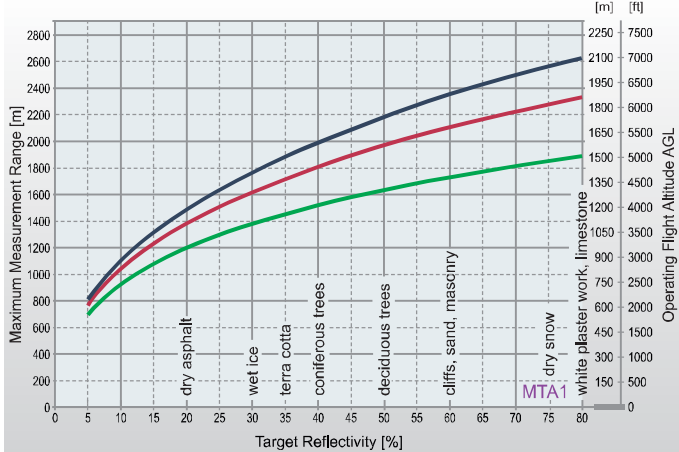

MTA1: no ambiguity / 1 transmitted pulse „in the cir“

— @ visibility 23 km  
 — @ visibility 15 km  
 — @ visibility 8 km

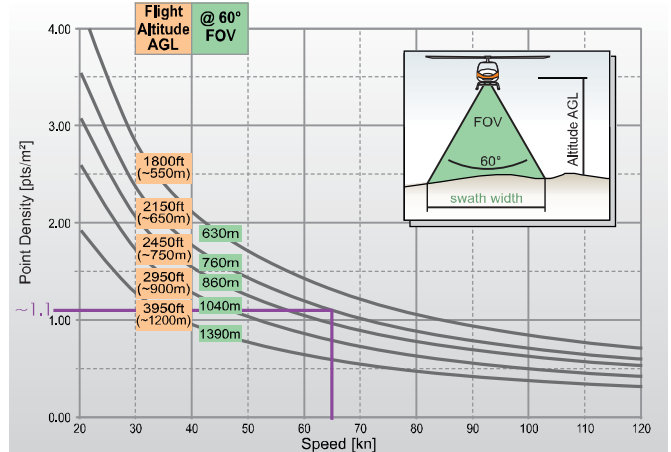

Example: VQ-580 at 50,000 pulses/second  
 Altitude = 2150ft AGL, Speed = 65 kn  
 Resulting Point Density ~ 1,1 pts/m<sup>2</sup>

**bottom view**

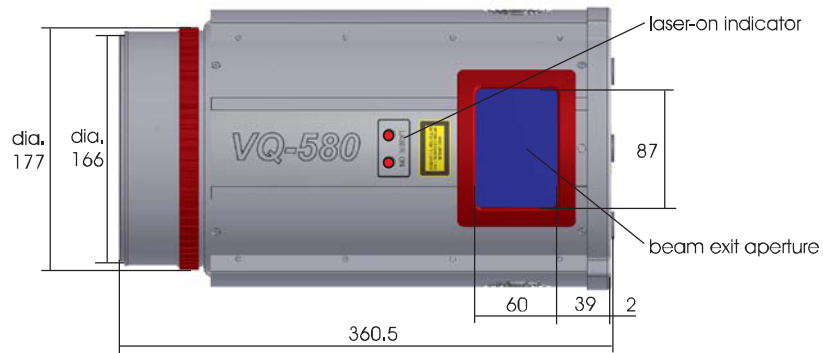

**front view**

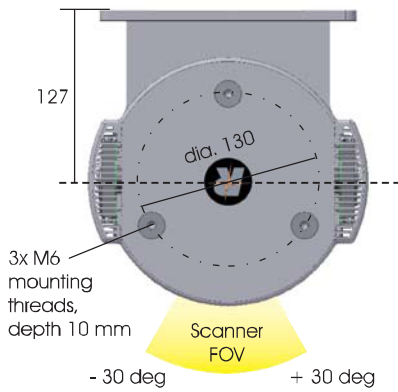

**side view**

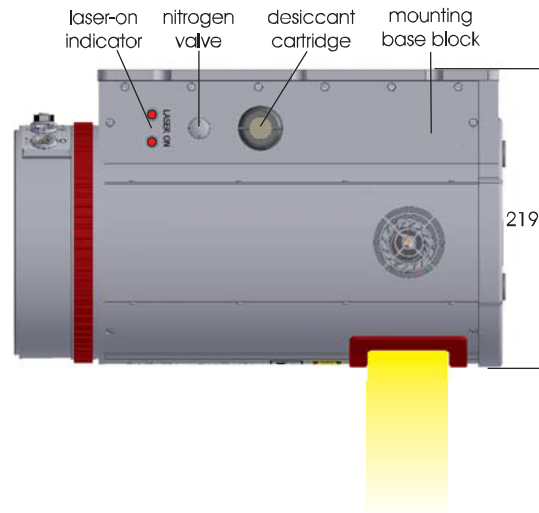

**rear view**

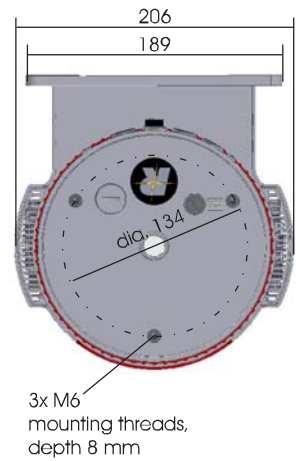

**top view**

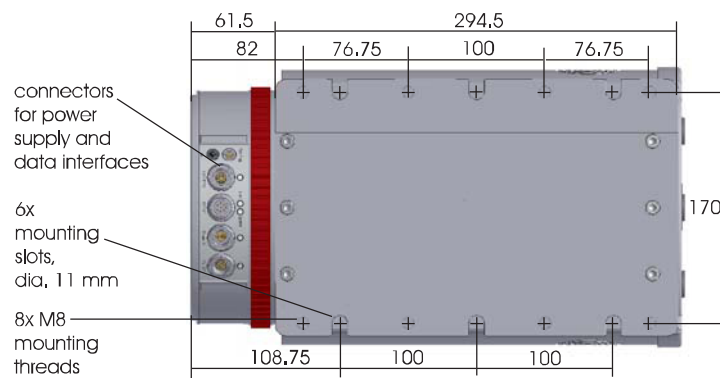

all dimensions in mm

# Technical Data *RIEGL* VQ®-580

## Laser Product Classification

Class 3B Laser Product according to IEC60825-1:2007

The instrument must be used only in combination with the appropriate laser safety box.

The following clause applies for instruments delivered into the United States: Complies with 21 CFR 1040.10 and 1040.11 except for deviations pursuant to Laser Notice No. 50, dated June 24, 2007.



## Range Measurement Performance Measuring Principle

time of flight measurement, echo signal digitization, online waveform processing

Laser Pulse Repetition Rate PRR <sup>1)</sup>	50 kHz	100 kHz	150 kHz	200 kHz	300 kHz	380 kHz
Effective Measurement Rate (meas./sec.) <sup>1) 2)</sup>	25 000	50 000	75 000	100 000	150 000	190 000
Max. Unambiguous Measuring Range <sup>3) 4) 5)</sup>						
natural targets $\rho \geq 20\%$	1500 m	1100 m	900 m	800 m	650 m	600 m
natural targets $\rho \geq 60\%$	2350 m	1750 m	1500 m	1300 m	1100 m	1000 m
Max. Operating Flight Altitude AGL <sup>2)</sup>	1200 m 3950 ft	900 m 2950 ft	750 m 2450 ft	650 m 2150 ft	550 m 1800 ft	500 m 1650 ft
Max. Number of Targets per Pulse	practically unlimited (details on request)					
NOHD <sup>6)</sup>	72 m	37 m	18 m	1 m	-	-
eNOHD <sup>7)</sup>	555 m	337 m	249 m	1 m	1 m	1 m

1) Rounded values.  
2) Reflectivity  $\rho \geq 20\%$ ,  $\pm 30^\circ$  FOV, additional roll angle  $\pm 5^\circ$ .  
3) The following conditions are assumed: target larger than the footprint of the laser beam, perpendicular angle of incidence, visibility 23 km, average ambient brightness.  
4) In bright sunlight the operational range may be considerably shorter and the operational flight altitude may be considerably lower than under an overcast sky.  
5) Ambiguity to be resolved by post-processing with RiMTA ALS software.  
6) Nominal Ocular Hazard Distance, based upon MPE according to IEC60825-1:2007, for single pulse condition  
7) Extended Nominal Ocular Hazard Distance, based upon MPE according to IEC60825-1:2007, for single pulse condition

## Minimum Range <sup>8)</sup>

Accuracy <sup>9) 11)</sup>

Precision <sup>10) 11)</sup>

Laser Pulse Repetition Rate <sup>1) 12)</sup>

Max. Effective Measurement Rate <sup>1)</sup>

Echo Signal Intensity

Laser Wavelength

Laser Beam Divergence <sup>13)</sup>

Laser Beam Footprint (Gaussian Beam Definition)

10 m

25 mm

25 mm

up to 380 kHz

up to 190 000 meas./sec. (@ 380 kHz PRR &  $60^\circ$  FOV)

for each echo signal, high-resolution 16 bit intensity information is provided near infrared

0.2 mrad

22 mm @ 100 m, 52 mm @ 250 m, 102 mm @ 500 m

8) Limitation for range measurement capability does not consider laser safety  
9) Accuracy is the degree of conformity of a measured quantity to its actual (true) value.

10) Precision, also called reproducibility or repeatability, is the degree to which further measurements show the same result.

11) One sigma @ 150 m range under *RIEGL* test conditions.

12) User selectable.

13) Measured at the  $1/e^2$  points. 0.20 mrad correspond to an increase of 20 cm of beam diameter per 1000 m distance.

## Scanner Performance

Scanning Mechanism

Field of View (selectable)

Scan Speed (selectable)

Angular Step Width  $\Delta \theta$  (selectable)

between consecutive laser shots

Angle Measurement Resolution

Internal Sync Timer

Scan Sync (optional)

rotating polygon mirror

$60^\circ (+30^\circ / -30^\circ)$

10 - 150 scans/sec

$0.003^\circ \leq \Delta \theta \leq 0.36^\circ$

0.001°

for real-time synchronized time stamping of scan data  
scanner rotation synchronization

## Data Interfaces

Configuration

Scan Data Output

GPS-System

LAN 10/100/1000 Mbit/sec

LAN 10/100/1000 Mbit/sec

Serial RS232 interface for data string with GPS-time information,  
TTL input for 1PPS synchronization pulse

## Mechanical Interfaces

Mounting of the Laser Scanner

Mounting of IMU sensor

mounting base block (with 8 x M8 thread inserts and 6x mounting slots)

3 x M6 thread inserts in the rear and the front plate  
(rigidly coupled with the internal mechanical structure)

## General Technical Data

Power Supply Input Voltage

Current Consumption

Main Dimensions / Weight

Humidity

Protection Class

Max. Flight Altitude (operating)

Max. Flight Altitude (not operating)

Temperature Range

18 - 32 V DC

typ. 65 W

360.5 x 206 x 219 mm (length x width x height), approx. 13 kg

max. 80 % non condensing @  $+31^\circ\text{C}$

IP64, dust and splash-proof

16 500 ft (5 000 m) above MSL

18 000 ft (5 500 m) above MSL

$-10^\circ\text{C}$  up to  $+40^\circ\text{C}$  (operation) /  $-20^\circ\text{C}$  up to  $+50^\circ\text{C}$  (storage)



Edificio Antalla  
Albasanz, 16  
28037 MADRID  
Tel. 91 567 97 00  
Fax: 91 570 26 61  
[www.alavaingenieros.com](http://www.alavaingenieros.com)



[www.riegl.com](http://www.riegl.com)